

Series 2000 Workcentre

OPERATING & SAFETY INSTRUCTIONS

Reeks 2000 Workcentre

BEDIENINGS- EN VEILIGHEIDSINSTRUCTIES

Série Workcentre 2000

INSTRUCTIONS D'UTILISATION ET CONSIGNES DE SECURITE

Reihe Workcentre 2000

BEDIENUNGS- & SICHERHEITSANWEISUNG

Serie Workcentre 2000

ISTRUZIONI PER L'USO E LA SICUREZZA

Serie Workcentre 2000

INSTRUCCIONES DE FUNCIONAMIENTO Y SEGURIDAD



Thank you for purchasing this Triton tool. These instructions contain information necessary for safe and effective operation of this product.

This product has a number of unique features. Even if you are familiar with this Workcentre, please read this manual to make sure you get the full benefit of its unique design.

Keep this manual close to hand and ensure all users of this tool have read and fully understood the instructions.

CONTENTS

Specifications	2
Parts List	3
Safety	4
Symbols	5
Fitting the Triton Saw	6
Warranty	9
Declaration of Conformity	54

SPECIFICATIONS

Part no:	WCA201
Suits:	Most circular saws (185mm - 235mm)
Cuts:	Rip, mitre, 45° bevel rip, crosscut, bevel crosscut, compound mitre
Rip capacity:	0 - 620mm
Crosscut capacity:	Up to 500mm wide
Standing size:	900mm x 600mm x 1300mm approx
Folded size:	350mm x 440mm x 1000mm approx
Standard features:	3 sided protractor (adjusts 45° to 0° to 45°), rip fence with 45° bevel face, folding legs, switchbox with safety shut-off, blade guard with dust port and kick-back protection, quick-release saw clamps, saw side guard, crosscut fence, guided push stick & side pressure finger kit
Optional Accessory Range:	sliding extension table, router table, jigsaw kit, biscuit joiner, finger jointer, planer attachment kit, dust collection, bevel ripping guide, height winder, retractable wheels

Protect your hearing

Always use proper hearing protection when tool noise exceeds 85dB.

PARTS LIST

A. Table (1)

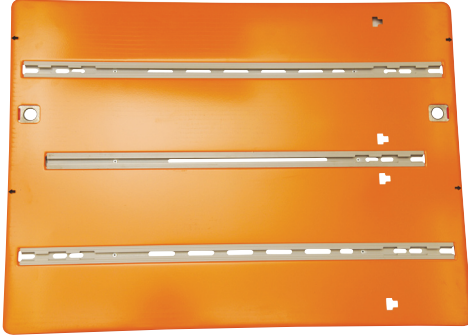

B. Front end panel (1)



C. Rear end panel (1)



F. Base channels (2)



E. Bearing channels (2)



I. Rip fence (1)



H. Crosscut fence (1)



L. Slide chassis (1)



J. Overhead guard & guard support (1)



M. Guided push-stick & side pressure finger kit

G. Protractor (1)



K. Side guard (2)



N. Rip fence bevel guides (2)



D. Legs (4)



MAIN FASTENER BAG



a. Leg locking pin (4)



b. M8 x 16 bolt (4)



c. M8 flange nut (4)



d. 8mm washer (20)



e. M8 nyloc nut (8)



f. M8 x 50 bolt (8)



g. Push-stick hanger (2)



h. M5 nyloc nut (3)



i. M5 x 8 screw (2)



j. M5 x 25 screw (1)

k. Saw locators (4)

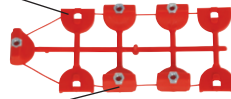

l. Clamping knobs (4)



m. M6 x 40 screw (4)



n. M6 flange nut (4)

o. Saw alignment cams



p. Angled foot (4)



q. Trigger strap (1)



r. Fence hanger (2)



s. Tube spanner (1)



u. Scale pointer labels (1)

GENERAL SAFETY INSTRUCTIONS



WARNING. Read all safety warnings and all instructions. Failure to follow the warnings and instructions may result in electric shock, fire and/or serious injury.

Save all warnings and instructions for future reference.

The term “power tool” in the warnings refers to your mains-operated (corded) power tool or battery operated (cordless) power tool.

1. Work area safety

- a. Keep work area clean and well lit. Cluttered and dark areas invite accidents.
- b. Do not operate power tools in explosive atmospheres, such as in the presence of flammable liquids, gases or dust. Power tools create sparks which may ignite the dust or fumes.
- c. Keep children and bystanders away while operating a power tool. Distractions can cause you to lose control.

2. Electrical safety

- a. Power tool plugs must match the outlet. Never modify the plug in any way. Do not use any adaptor plugs with earthed (grounded) power tools. Unmodified plugs and matching outlets will reduce risk of electric shock.
- b. Avoid body contact with earthed or grounded surfaces such as pipes, radiators, ranges and refrigerators. There is an increased risk of electric shock if your body is earthed or grounded.
- c. Do not expose power tools to rain or wet conditions. Water entering a power tool will increase the risk of electric shock.
- d. Do not abuse the cord. Never use the cord for carrying, pulling or unplugging the power tool. Keep cord away from heat, oil, sharp edges or moving parts. Damaged or entangled cords increase the risk of electric shock.
- e. When operating a power tool outdoors, use an extension cord suitable for outdoor use. Use of a cord suitable for outdoor use reduces the risk of electric shock.
- f. If operating a power tool in a damp location is unavoidable, use a residual current device (RCD) protected supply. Use of an RCD reduces the risk of electric shock.

3. Personal safety

- a. Stay alert, watch what you are doing and use common sense when operating a power tool.

Do not use a power tool while you are tired or under the influence of drugs, alcohol or medication. A moment of inattention while operating power tools may result in serious personal injury.

- b. Use safety equipment. Always wear eye protection. Safety equipment such as dust mask, non-skid safety shoes, hard hat, or hearing protection used for appropriate conditions will reduce personal injuries.
- c. Avoid accidental starting. Ensure the switch is in the off position before plugging in. Carrying power tools with your finger on the switch or plugging in power tools that have the switch on invites accidents.
- d. Remove any adjusting key or wrench before turning the power tool on. A wrench or a key left attached to a rotating part of the power tool may result in personal injury.
- e. Do not overreach. Keep proper footing and balance at all times. This enables better control of the power tool in unexpected situations.
- f. Dress properly. Do not wear loose clothing or jewellery. Keep your hair, clothing and gloves away from moving parts. Loose clothes, jewellery or long hair can be caught in moving parts.
- g. If devices are provided for the connection of dust extraction and collection facilities, ensure these are connected and properly used. Use of these devices can reduce dust related hazards.

4. Power tool use and care

- a. Do not force the power tool. Use the correct power tool for your application. The correct power tool will do the job better and safer at the rate for which it was designed.
- b. Do not use the power tool if the switch does not turn it on and off. Any power tool that cannot be controlled with the switch is dangerous and must be repaired.
- c. Disconnect the plug from the power source before making any adjustments, changing accessories, or storing power tools. Such preventive safety measures reduce the risk of starting the power tool accidentally.
- d. Store idle power tools out of the reach of children and do not allow persons unfamiliar with the power tool or these instructions to operate the power tool. Power tools are

dangerous in the hands of untrained users.

- e. Always unplug your power tool when leaving unattended. Such preventative safety measures reduce the risk of starting the power tool accidentally by untrained users.
- f. Maintain power tools. Check for misalignment or binding of moving parts, breakage of parts and any other condition that may affect the power tools operation. If damaged, have the power tool repaired before use. Many accidents are caused by poorly maintained power tools.
- g. Keep cutting tools sharp and clean. Properly maintained cutting tools with sharp cutting edges are less likely to bind and are easier to control.
- h. Use the power tool, accessories and tool bits etc., in accordance with these instructions and in the manner intended for the particular type of power tool, taking into account the working conditions and the work to be performed. Use of the power tool for operations different from those intended could result in a hazardous situation.

5. Service

- a. Have your power tool serviced by a qualified repair person using only identical replacement parts. This will ensure that the safety of the power tool is maintained.

SYMBOLS

ENVIRONMENTAL PROTECTION



Waste electrical products should not be disposed of with household waste. Please recycle where facilities exist. Check with your local authority or retailer for recycling advice.



Always wear ear, eye and respiratory protection.



Double insulated for additional protection.



Instruction warning.



Do not use before viewing and understanding the full operating instructions



Refer to DVD for full instructions

FITTING THE TRITON 235MM POWER SAW

Fitting the slide chassis

Place the Slide Chassis (L) in the bearing channels with the red plastic catch and red bearing spacers closest to the front panel (the switch box end) and the flanges upwards. Enter two bearings in the channel cutouts. Slide the chassis towards the rear panel and the other bearings will drop in.



Spray the channels with lubricating oil for a smooth slide.

Fitting the triton saw

Unplug your saw. Check that the blade is set at 0° and at full depth of cut.

Fit the Saw Alignment Cams (o) from below, holding the bases in the rectangular slots while you screw into them. (They cut their own thread.) Make sure the lines moulded on top of the cams are both pointing towards the rear panel. Tighten the screws until nipped gently.

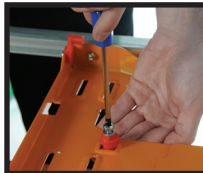
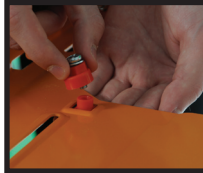

Fitting the saw locators and knobs

Fit the saw into the chassis with the alignment cams locating in the holes in the saw baseplate.

Break or cut the Saw Locators (k) and Clamping Knobs (l) from their moulding "tree" and carefully trim off any remnants with a sharp knife. Fit the saw locators in the slots shown using 4 M6 x 40 screws (m) and M6



Flange nuts (n). The straight edges should be against the baseplate, but spaced away from it slightly to allow for final saw adjustment.

(Use a spatula blade or a piece of cardboard or metal about 1mm thick as a spacer.) Firmly tighten the screws.



Screw the knobs on (they cut their own thread) until they just scrape against the top edge of the saw baseplate. This tension is sufficient to hold the saw upside-down for final adjustment, and still allow the saw to be shifted sideways slightly using the alignment cams.

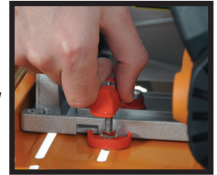

Check that the saw is securely mounted. Turn the slide chassis over, re-engaging the bearings in the channels.



Aligning the saw

Position the chassis halfway between the end panels. Adjust the fence in close to the blade and lock it. Make sure the blade is vertical by comparing it to the face of the fence. If necessary, loosen the nut holding the Blade Angle Trimmer, and adjust the blade angle. Re-tighten the nut.



Use the saw's spanner or the Tube Spanner (s) to rotate the cams until the front and rear of the



blade are just touching the fence, when it is at 0mm. When satisfied with the position tighten the alignment cam screws.

Unscrew the front handle of the saw for better access to the front cam. Lower the blade for access to the rear one.

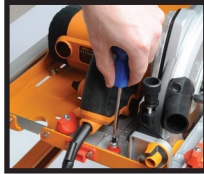

Final clamping of saw

Double-check the saw position by now locking the fence at 0mm, and trying to turn the blade backwards by hand. The teeth should lightly scrape against the face of the fence. If not, repeat the above alignment.



This is a very important step, because it will ensure that your saw cuts are true, and that your fence scales are accurate, so take your time.

When satisfied with the position of the saw, reposition the saw locators hard up against the edge of the baseplate, as follows. Hold each knob against turning and loosen the screw about half to one turn. Push the saw locator into position, and firmly tighten the screw.

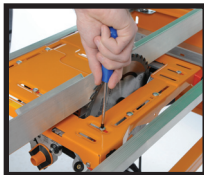

Turn the saw right-way up again and loosen the four knobs a couple of turns. Check that the saw cannot move sideways at all, and that all screws are fully tightened. Do up the knobs again, perhaps

one turn beyond when they first scrape on the baseplate.

The saw is now set up, and is available at any time for hand-held use by simply loosening each knob half a turn and lifting the saw straight up. If the locators are correctly fitted, the saw will go back into exactly the right spot each time.



Fitting the side guard

Slide the two sections of the Side Guard (K) together until they fit between the pivot brackets on the slide chassis. Loosely fit the short M5 x 8 screw (i) and a M5 Nyloc nut (h) to hold them together.

Fit the two longer M5 x 25 screws (j) and M5 Nyloc nuts through the pivot brackets and into the guard flanges. Tighten until the guard is firm, but still free to pivot. Finally, tighten the screw holding the two halves together.



Fitting the trigger strap

 Before fitting the Trigger Strap (q) always ensure that the saw is disconnected from the power and that the switch on the Workcentre front panel is in the "OFF" position.

Wrap the Trigger Strap (q) around the handgrip with the furry side facing outwards. Pass the strap through the buckle, until the security loop has passed through. If your saw has a safety lock-out button press it and then tighten the strap until the trigger clicks "ON".

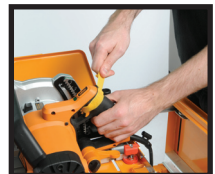

GB

Wrap the free end of the strap around the handgrip.

With most saws, the strap can be slid on and off the saw trigger, without undoing it each time.

Do not leave the trigger strap permanently locked on. When you have finished work for the day, release the strap and allow the spring in the trigger to relax.



Fitting the table

Turn the slide chassis upside down. Position it roughly half-way between the end panels. The front of the saw must be facing the front panel (switchbox end).

Lower the Table (A) over the blade, with the four T-slots closest to the rear panel. Line up the arrows on the edges of the table with the scale pointers on top of the end panels.

Push the table latches to the "LOCK" position. The red indicators disappear from view when the latches fully locate.



UNLOCKED

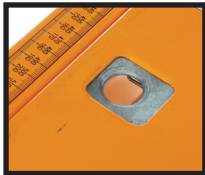

LOCKED

Reach underneath and push the slide chassis towards the rear panel until the red catch "clicks" home and locks the chassis underneath the table.



Fitting the overhead guard & support

Loosen the knob on the Overhead Guard (J) to remove the Guard Support from its shipping position. Fit the support to the centre table slot, using the cut-outs at the end. Ensure the saw blade is adjusted to its maximum depth, then position the support about 12mm behind the blade and lock it in by pressing the locking lever down.

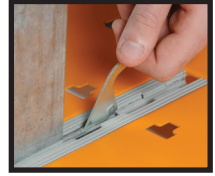

Lubricate the entry if it's a tight fit. Check the guard support is reasonably square to the table, and adjust it if necessary by pushing evenly with your hand or a block of wood.



Hold 2 straight pieces of wood lightly against the blade. The overhead guard support should fit between the pieces.



If not, you may have to adjust the saw position slightly. This is only likely if you have a very thin kerf blade (2.0 - 2.2mm cut width)

Fit and lower the guard. Spin the blade by hand before connecting the power to ensure it is not touching anything.



! Always make sure the blade is at full height, the guard is fitted, and the table is locked to the end panels before switching on the power. Check that the teeth on your blade are pointing in the same direction as the etched symbols on the guard. If not, you have incorrectly fitted the blade to your saw.

Connecting the power

Make sure the switch is "OFF", plug the saw into the switch box, and bring power to the switch box via a suitably rated extension cord.

Press the white switch with your finger to switch the power "ON". Tap the stop plate with your hand or knee to switch "OFF"



Switch the power on and off and watch the blade. If it quivers sideways on start-up it's a sign of a worn arbor in your saw, or excessive slack in the mountings between the motor and baseplate.

If the blade vibrates significantly at full speed or on slow-down, it's either buckled or not seated properly on the arbor. Check the flatness of the blade with a straight edge, check the fit of any arbor-reducing washers, and check for resin/sawdust build-up on the arbor or flange washers.

A slight quiver is generally noticeable on slow-down in most blades, and shouldn't affect your cuts.

WARRANTY

To register your guarantee visit our web site at www.tritontools.com* and enter your details.

Your details will be included on our mailing list (unless indicated otherwise) for information on future releases. Details provided will not be made available to any third party.

PURCHASE RECORD

Date of Purchase: ___ / ___ / ___

Model: WCA201

Serial Number: _____

(Located on motor label)

Retain your receipt as proof of purchase

Triton Precision Power Tools guarantees to the purchaser of this product that if any part proves to be defective due to faulty materials or workmanship within 12 MONTHS from the date of original purchase, Triton will repair, or at its discretion replace, the faulty part free of charge.

This guarantee does not apply to commercial use nor does it extend to normal wear and tear or damage as a result of accident, abuse or misuse.

* Register online within 30 days.

Terms & conditions apply.

This does not affect your statutory rights

Dit product heeft een aantal unieke kenmerken. Lees deze handleiding a.u.b., zelfs als u bekend bent met deze Workcentre, zodat u optimaal profiteert van het unieke ontwerp.

Houd deze handleiding bij de hand en zorg ervoor dat alle gebruikers van dit gereedschap de instructies hebben gelezen en volledig hebben begrepen.

INHOUD

Specificaties	10
Onderdelenlijst	11
Veiligheid	12
Symbolen	13
Montage van de Triton zaag	14
Garantie	17
Eg-verklaring van overeenstemming	54

SPECIFICATIES

Onderdeelnr:	WCA201
Geschild voor:	De meeste cirkelzagen (185mm - 235mm)
Bewerkingen:	schulp, verstek, 45° schulp, doorsnede, schuine doorsnede, samengesteld verstek
Schulpcapaciteit:	0 - 620mm
Doorsnedecapaciteit:	tot 500 mm breed
Afmetingen uitgeklaapt:	ca 900mm x 600mm x 1300mm
Afmetingen ingeklaapt:	ca 350mm x 440mm x 1000mm
Standaardkenmerken:	3 zijdige hoekmeter (45° tot 0° tot 45°), langsegeleider met 45° vlak, inklappoten, schakelkast met beveiliging, zaagafscherming met stofafvoeropening en terugslagbeveiliging, zaagklemmen met snelkoppeling, zaagzijfscherming, doorsnedegeleider, veiligheidsdrukker en zijdrukvinger
Optionele accessoires:	uitschuiftafel, freestafel, decoupeerzaagset, lamellenfrees, finger jointer, schaafmontageset, stofverzameling, afschuiningsgeleider, hoogtedraaistelling, intrekbare wielen

Bescherm uw gehoor

Draag altijd geschikte gehoorbescherming bij gereedschap dat een geluidsniveau van meer dan 85dB produceert.

ONDERDELENLIJST

A. Tafel (1)

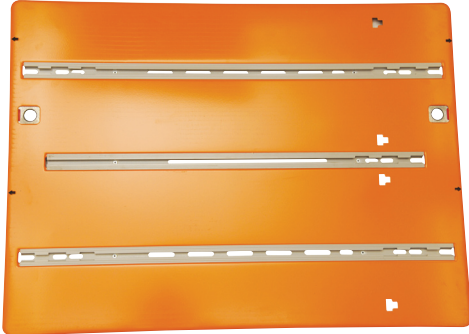

H. Doorsnedegeleider (1)



B. Voorpaneel (1)



C. Achterpaneel (1)



L. Schuifchassis (1)

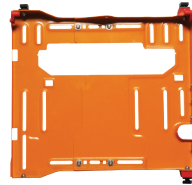

J. Bovenafscherming en afschermingsteun (1)



M. Geleide duwstok en zijdrukvingerset

F. Basiskanalen (2)



G. Hoekmeter (1)



K. Zijafscherming (2)



E. Lagerkanalen (2)



N. Langsgeleider met schuingeleiding (2)



I. Langsgeleider (1)



D. Poten (4)



ZAK MET BEVESTIGINGSMIDDELEN



a. Pootvergrenselingspen (4)



b. M8 x 16 bout (4)



c. M8 flensmoer (4)



d. 8mm sluitring (20)



e. M8 nyloc moer (8)



f. M8 x 50 bout (8)



g. Duwstokhanger (2)



h. M5 nyloc moer (3)



i. M5 x 8 schroef (2)



j. M5 x 25 schroef (1)

k. Zaaglocaties (4)

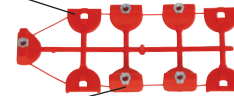

l. Klemknoppen (4)



m. M6 x 40 schroef (4)



n. M6 flensmoer (4)
o. De groepeeringsnokken van de zaag



p. Schuine voet (4)



q. Trekkerband (1)



r. Geleiderhanger (2)



s. Slang sleutel (2)



u. Etiketten
schaalwijzer (2)



WAARSCHUWING. Lees alle veiligheidsmeldingen en alle instructies. Het niet navolgen van alle waarschuwingen en instructies kan resulteren in een elektrische schok, brand en/of ernstig letsel.

Bewaar alle waarschuwingen en instructies voor later.

De term "elektrisch gereedschap" in alle hieronder vermelde waarschuwingen hebben betrekking op gereedschap dat ofwel op het lichtnet werkt (via een stroomsnoer) of op batterijen (snoerloos).

1. Werkplaatsveiligheid

- Houd het werkgebied schoon en zorg voor een goede verlichting. Rommelige en donkere ruimtes leiden vaak tot ongelukken.
- Werk niet met elektrisch gereedschap in explosieve omgevingen, zoals bijvoorbeeld in de aanwezigheid van ontvlambare vloeistoffen, gassen of stof. Elektrisch gereedschap veroorzaakt vonken die het stof of de dampen kunnen ontsteken.
- Houd kinderen en omstanders uit de buurt wanneer u elektrisch gereedschap bedient. Door afleiding kunt u de controle over het gereedschap verliezen.

2. Veiligheid met betrekking tot elektriciteit

- De stekkers van het elektrische gereedschap moeten overeenkomen met het stopcontact. U mag op geen enkele manier de stekker aanpassen. Gebruik geen adapterstekkers bij geaard elektrisch gereedschap. Met het gebruik van ongewijzigde stekkers en bijpassende stopcontacten wordt het risico op een elektrische schok verminderd.
- Vermijd lichamelijk contact met geaarde oppervlakken zoals pijpen, radiatoren, fornuizen en koelkasten. Het risico op een elektrische schok neemt toe als uw lichaam geaard is.
- Laat elektrisch gereedschap niet nat worden. Wanneer elektrisch gereedschap nat wordt, neemt het risico op een elektrische schok toe.
- Beschadig het snoer niet. Gebruik het snoer nooit om te dragen, te trekken of om de stekker uit het stopcontact te trekken. Houd het snoer verwijderd van hitte, olie, scherpe randen en bewegende delen. Met beschadigde of in de knoop geraakte snoeren neemt het risico op een elektrische schok toe.

- Wanneer u elektrisch gereedschap buiten gebruikt, maak dan gebruik van een verlengsnoer dat geschikt is voor gebruik buitenshuis. Het gebruik van een snoer dat geschikt is voor gebruik buitenshuis vermindert het risico op een elektrische schok.
- Als elektrische gereedschap toch in een vochtige omgeving moet worden gebruikt, beveilig de stroomvoorziening dan met een reststroombreker. Het gebruik van een reststroombreker vermindert het risico op een elektrische schok.

3. Persoonlijke veiligheid

- Blijf alert, houd uw aandacht bij uw werk en gebruik uw gezond verstand wanneer u elektrisch gereedschap bedient. Gebruik het elektrisch gereedschap niet wanneer u vermoeid bent of onder invloed van drugs, alcohol of medicijnen. Eén moment van onoplettendheid tijdens het bedienen van elektrisch gereedschap kan leiden tot ernstig persoonlijk letsel.
- Maak gebruik van veiligheidsuitrusting. Draag altijd oogbescherming. Het gebruik van veiligheidsvoorzieningen zoals stofmaskers, slipvrije veiligheidsschoenen, helmen en gehoorbescherming indien van toepassing vermindert het risico van persoonlijk letsel.
- Vermijd dat het per ongeluk wordt gestart. Eel vast dat de schakelaar in de uit-stand staat voordat u de stekker in het stopcontact steekt. Het dragen van elektrisch gereedschap met uw vinger op de schakelaar of het aansluiten op de stroom van elektrisch gereedschap met de schakelaar ingeschakeld kan tot ongelukken leiden.
- Verwijder alle stel- of moersleutels voordat u het elektrisch gereedschap inschakelt. Een moer- of stelsleutel die zich op een draaiend onderdeel van het elektrische gereedschap bevindt, kan persoonlijk letsel veroorzaken.
- Reik niet te ver. Blijf altijd stevig en in balans staan. Zo houdt u meer controle over het elektrisch gereedschap in onverwachte situaties.
- Draag geschikte kleding. Draag geen loshangende kleding of sieraden. Houd uw haar, kleding en handschoenen weg van bewegende delen. Losse kleding, sieraden en lang haar kan in bewegende onderdelen verward raken.

g. Als er onderdelen voor stofafvoer- en stofverzameling worden meegeleverd, sluit deze dan aan en gebruik deze op de juiste wijze. Het gebruik van deze onderdelen kan het risico op stofgerelateerde ongelukken verminderen.

4. Gebruik en verzorging van elektrisch gereedschap

- a. Forceer elektrisch gereedschap niet. Gebruik elektrisch gereedschap dat geschikt is voor het werk dat u wilt uitvoeren. Geschikt elektrisch gereedschap werkt beter en veiliger op de snelheid waarvoor het is ontworpen.
- b. Gebruik het elektrisch gereedschap niet als de schakelaar het apparaat niet in- en uitschakelt. Elektrisch gereedschap dat niet bediend kan worden met de schakelaar is gevaarlijk en moet gerepareerd worden.
- c. Haal de stekker uit het stopcontact voordat u instellingen verandert, accessoires verwisselt of het gereedschap opbergt. Dergelijke voorzorgsmaatregelen verminderen het risico op het per ongeluk starten van het gereedschap.
- d. Berg elektrisch gereedschap dat niet in gebruik is buiten bereik van kinderen op en laat mensen die niet bekend zijn met het elektrische gereedschap of met deze instructies het elektrische gereedschap niet bedienen. Elektrisch gereedschap is gevaarlijk in de handen van onervaren gebruikers.
- e. Haal altijd de stekker van het elektrisch gereedschap uit het stopcontact indien u dit onbeheerd achterlaat. Dergelijke preventieve

veiligheidsmaatregelen verminderen het risico op het per ongeluk starten van het elektrische gereedschap door ongeoefende gebruikers.

- f. Onderhoud elektrisch gereedschap. Controleer op foutieve uitlijning of het vastslaan van bewegende delen, gebroken onderdelen en elke andere afwijking die de werking van het elektrische gereedschap zou kunnen beïnvloeden. Indien het elektrische gereedschap beschadigd is, moet u het laten repareren voordat u het weer gebruikt. Veel ongelukken worden veroorzaakt door slecht onderhouden elektrisch gereedschap.
- g. Houd zaaggereedschap scherp en schoon. Goed onderhouden en goed geslepen zaaggereedschap slaat minder snel vast en is gemakkelijker te bedienen.
- h. Gebruik het elektrische gereedschap, de accessoires en onderdelen etc. volgens deze instructies en zoals is bedoeld voor elk specifiek type elektrisch gereedschap, en houd daarbij rekening met de werkomstandigheden en het uit te voeren werk. Gebruik van elektrisch gereedschap voor werkzaamheden die verschillen van die waarvoor het apparaat bestemd is, kan leiden tot een gevaarlijke situatie.

5. Onderhoud

- a. Laat uw elektrische gereedschap onderhouden door een gekwalificeerde vakman en gebruik alleen identieke vervangende onderdelen. Zo bent u er zeker van dat de veiligheid van het elektrische gereedschap gewaarborgd blijft.

SYMBOLEN

BESCHERMING VAN HET MILIEU



Elektrische producten mogen niet worden afgevoerd met het normale huisvuil. Indien de mogelijkheid bestaat, dient u het product te recyclen. Vraag de plaatselijke autoriteiten of winkelier om advies betreffende recyclen.



Draag altijd oor-, oog- en luchtwegenbescherming.



Dubbel geïsoleerd.



Instructie waarschuwing.



Gebruik niet alvorens en begrijpend de volledige werkende instructies te bekijken



Raadpleeg dvd voor volledige instructies

MONTAGE VAN DE TRITON 235MM ELEKTRISCHE ZAAG

Montage van het zijchassis

Plaats het zijchassis (L) in de lagerkanalen met de rode plastic pal en de rode afstandsbusen het dichtst bij het voorpaneel (de kant van de schakelkast) en met de flenzen naar boven. Stop twee lagers in de kanaaluitsparingen. Schuif het chassis naar het achterpaneel toe zodat de andere lagers er in vallen.

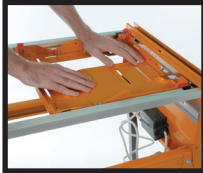

Spuut RP7 of WD40 in de kanalen voor een soepele schuifbeweging.

Montage van de triton zaag

Haal de stekker van de zaag uit het stopcontact. Stel vast dat het zaagblad op 0° is ingesteld en op de volle zaagdiepte.

Breng de uitlijnnokken van de zaag (o) vanaf de onderkant aan en houd ze aan de onderkant in de rechthoekige sleuven terwijl u er in schroeft. (Ze maken hun eigen schroefdraad.) Zorg ervoor de lijnen op de bovenkant van de nokken naar het achterpaneel toe zijn gericht. Draai de schroeven aan totdat ze net ingrijpen.

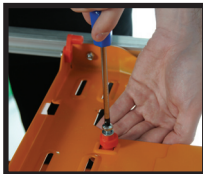

Montage van de zaaglocaties en knoppen

Breng de zaag aan in het chassis met de uitlijnnokken in de gaten in de basisplaat van de zaag.

Breek of snij de zaaglocaties (k) en knoppen (l) uit de 'boom' en verwijder eventuele bramen met een scherp mes.



Breng de zaaglocaties in de aangeduide sleuven aan met vier kruiskopschroeven (m) en flensmoeren (n). De rechte kanten moeten tegen de basisplaat zitten, maar met een kleine tussenruimte om een laatste bijstelling van de zaag mogelijk te maken.

(Gebruik het blad van een spatel of een stuk karton of metaal van ongeveer 1 mm dikte voor de tussenruimte.) Draai de schroeven stevig aan.

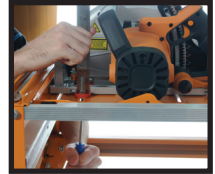

Draai de knoppen er op (ze maken hun eigen schroefdraad) totdat ze net de bovenrand van de basisplaat raken. De spanning is voldoende om de zaag ondersteboven te houden voor de laatste bijstelling en toch een kleine zijwaartse beweging mogelijk te maken met behulp van de uitlijnnokken.

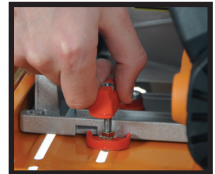

Controleer of de zaag stevig is gemonteerd. Draai het schuifchassis om en breng de lagers weer in de kanalen aan.



De zaag uitlijnen

Plaats het chassis halverwege de eindpanelen. Stel de geleider dicht tegen de zaag aan en zet hem vast. Zorg ervoor dat het zaagblad verticaal is in vergelijking met het vlak van de geleider. Draai zo nodig de moer los waarmee de hoek van het zaagblad is ingesteld en stel de hoek bij. Draai de moer weer aan.



Gebruik de steeksleutel van de zaag of de slang sleutel (s) om de nokken te draaien totdat de voor- en achterkant van het zaagblad de geleider net raken, bij 0 mm. Als u tevreden bent met de positie moeten de uitlijnnokken worden vastgedraaid met de schroeven.

Draai de voorhendel van de zaag los om beter bij de voorste nok te kunnen. Laat het zaagblad zakken om bij de achterste nok te kunnen.



De zaag tenslotte vastklemmen

Controleer de positie van de zaag nogmaals door de geleider op 0 mm vast te zetten en draai het zaagblad vervolgens met de hand naar achteren. De tanden moeten net tegen het vlak van de geleider schrapen. Als dit niet zo is moet de bovenstaande uitlijning worden herhaald.



Dit is een zeer belangrijke stap omdat het ervoor zorgt dat de zaagsnede correct is en dat de schaal van de geleider klopt. Neem er dus de tijd voor.

Als u tevreden bent met de positie van de zaag breng dan de zaaglocaties stevig tegen de rand van de basisplaat aan, zie onder. Voorkom voor elke knop dat hij draait

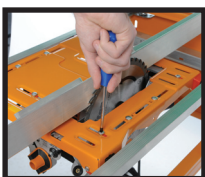

en draai de schroef ongeveer een halve slag los. Duw de zaaglocatie op zijn plaats en draai de schroef stevig aan.

Zet de zaag weer rechtop en draai de vier knoppen een paar slagen los. Stel vast dat de zaag helemaal niet zijwaarts kan bewegen en dat alle schroeven goed zijn aangedraaid. Draai de knoppen weer aan, misschien een extra slag verder dan wanneer ze voor het eerst de basisplaat raken.

De zaag is nu opgesteld en kan op elk moment als handgereedschap worden gebruikt door elke knop een halve slag te draaien en de zaag recht omhoog te tillen. Als de locaties goed zijn aangebracht keert de zaag telkens precies terug naar de juiste plaats.



Montage van de zijafscherming

Schuif de twee stukken van de zijafscherming (K) samen tot ze tussen de draaibeugels op het schuifchassis passen. Breng de korte kruiskopschroef (i) losjes aan met een Nyloc moer (h) om ze samen te houden.

Breng de twee langere kruiskopschroeven (j) en Nyloc moeren door de draaibeugels en in de flenzen van de afscherming aan. Draai ze aan totdat de afscherming goed vast zit, maar nog wel kan draaien. Draai ten slotte de schroef aan die de twee helften tegen elkaar houdt.



Montage van de trekkerband

 Voordat de trekkerband (q) wordt gemonteerd moet u er altijd voor zorgen dat de stekker van de zaag uit het stopcontact is gehaald en dat de schakelaar op het voorpaneel van de Workcentre op uit staat ('OFF').

Wikkel de trekkerband (q) om de handgreep heen met het bont naar buiten toe. Voer de riem door de gesp heen totdat de veiligheidslus

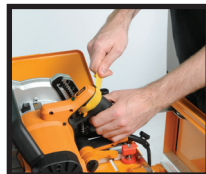

er doorheen is gehaald. Als uw zaag voorzien is van een beveiligingsknop druk die dan in en haal de riem aan totdat de trekker aan klikt ('ON').

Wikkel het losse eind van de riem om de handgreep heen.

Bij de meeste zagen kan de riem op en af de trekker worden geschoven zonder dat hij telkens los hoeft te worden gemaakt.

Laat de trekkerband er niet permanent op zitten. Als u het werk voor die dag af hebt, maak dan de riem los zodat de spanning van de veer in de trekker wordt weggenomen.



Montage van de tafel

Zet het schuifchassis ondersteboven. Plaats het ongeveer halverwege tussen de eindpanelen. De voorkant van de zaag moet naar het voorpaneel zijn gericht (de kant van de schakelkast).

Laat de tafel (A) over het zaagblad zakken, met de vier T-gleuven het dichtst bij het achterpaneel. Breng de pijltjes op de randen van de tafel in lijn met de pijltjes van de schaal boven op de eindpanelen. Duw de grendels van de tafel in de vergrendelde stand ('LOCK'). De rode indicators zijn niet meer zichtbaar wanneer de grendels goed op hun plaats zitten.



UNLOCKED



LOCKED

Duw het schuifchassis aan de onderkant van de tafel naar het achterpaneel toe totdat de rode grendel vastklikt en het chassis aan de onderkant van de tafel vergrendelt.



Montage van de bovenafscherming en steun

Maak de knop op de bovenafscherming (J) los om de afschermingsteun uit de transportpositie te verwijderen. Monteer de steun op de middelste gleuf in de tafel, met de uitsnedes aan het eind. Zorg ervoor dat het zaagblad op maximale diepte is afgesteld en plaats de steun vervolgens ongeveer 12 mm achter het zaagblad en zet hem vast door de vergrendelingshendel omlaag te duwen.



Smeer de verbinding zo nodig. Controleer of de steun redelijk haaks op de tafel staat en stel hem zo nodig bij door gelijkmatig drukken met de hand of een blok hout.



Houd 2 rechte stukken hout lichtjes tegen het zaagblad aan. De bovenafschermingsteun moet tussen de stukken in passen.

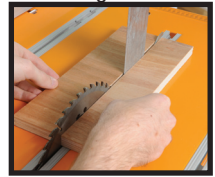

Zo niet, dan kan de positie van de zaag een beetje worden bijgesteld. Dit is waarschijnlijk alleen het geval als u een zaagblad met een hele dunne kerf gebruikt (2,0 - 2,2 mm zaagbreedte).

Monteer de afscherming en laat hem zakken. Draai het zaagblad met de hand voordat u hem aansluit op het stopcontact, om er zeker van te zijn dat hij niets aanraakt.



Zorg er altijd voor dat het zaagblad op de

volle hoogte staat, de afscherming is aangebracht, en de de tafel aan de eindpanelen is vergrendeld, voordat u de stroom inschakelt. Controleer of de richting van de tanden van het zaagblad klopt met de aanduiding op de afscherming. Zo niet, dan is het zaagblad verkeerd in de zaag aangebracht.

De stroom aansluiten

Zorg ervoor dat de schakelaar uit staat ('OFF'), sluit de zaag aan op de schakelkast en sluit de stroom aan op de schakelkast via een verlengsnoer met geschikt vermogen.

Druk met uw vinger op de witte schakelaar om de stroom aan te zetten ('ON'). Tik met uw hand of knie op de stopplaat om hem uit te schakelen ('OFF').



Schakel de stroom in en uit en inspecteer het zaagblad. Als het bij het opstarten zijwaarts wiebelt wil dat zeggen dat de spil van uw zaag versleten is of dat er te veel speling zit in de montage van de motor en de basisplaat.

Als het blad op volle toeren of bij het vertragen veel trilt is hij ofwel krom of zit hij niet goed op de spil. Controleer met een liniaal of het zaagblad recht is, controleer de montage van ringen op de spil en controleer op opgehoopte hars/zaagsel op de spil of op de flensringen.

Een lichte wiebel bij het vertragen is normaal en moet geen invloed hebben op de zaagsnede.

GARANTIE

Om uw garantie te registreren, gaat u naar onze website op www.tritontools.com* en voert u uw gegevens in.

Uw gegevens worden opgeslagen in onze mailinglist (tenzij u anders aangeeft) voor informatie over nieuwe producten. De ingevulde gegevens worden dan geen enkele andere partij beschikbaar gesteld.

AANKOOPGEGEVENS

Datum van aankoop: ___ / ___ / ___

Model: WCA201

Serienummer: _____

(te vinden op motorlabel)

Bewaar uw aankoopbon als aankoopbewijs

Triton Precision Power Tools garandeert de koper van dit product dat indien een onderdeel defect is vanwege fouten in materiaal of uitvoering binnen 12 MAANDEN na de datum van de oorspronkelijke aankoop, Triton het defecte onderdeel gratis repareert of, naar eigen inzicht, vervangt.

Deze garantie heeft geen betrekking op commercieel gebruik en strekt zich niet uit tot normale slijtage of schade ten gevolge van een ongeluk, verkeerd gebruik of misbruik.

* Registreer online binnen 30 dagen.

Algemene voorwaarden van toepassing.

Dit heeft geen invloed op uw statutaire rechten

Ce produit possède de nombreuses caractéristiques exceptionnelles. Même si vous connaissez déjà cet établi Workcentre, veuillez lire ce manuel pour vous assurer de tirer pleinement profit de sa remarquable conception. Conservez ce manuel à portée de main et assurez-vous que tous les utilisateurs de cet outil ont lu et parfaitement compris ces instructions.

TABLE DES MATIERES

Spécifications	18
Liste des pièces	19
Sécurité	20
Symboles	22
Montage de la scie Triton	22
Garantie	26
Déclaration de conformité CE	54

SPECIFICATIONS

Référence:	WCA201
Applications:	La plupart des scies circulaires (185mm - 235mm)
Coupes:	Longitudinale, ongulaire (onglet), Longitudinale, biseautée à 45°, transversale, transversale biseautée, onglet combiné
Longueur coupe longitudinale:	0 - 620mm
Largeur maximum coupe transversale:	500mm
Dimensions:	Scie déployée: environ 900mm x 600mm x 1300mm
Dimensions:	Scie repliée: environ 350mm x 440mm x 1000mm
Caractéristiques standards:	Rapporteur 3 faces (réglages 45° à 0° à 45°), guide longitudinal avec face biseautée à 45°, jambes repliables, boîtier de commutateur avec arrêt sécurité, protège-lame avec orifice d'évacuation de poussière et protection contre le retour en arrière, fixations de scie à libération rapide, protection latérale de scie, guide de coupe transversale, poussoir de sécurité et doigt de pression latérale
Accessoires en option:	Rallonge de table coulissante, table de défonceuse, kit de scie à découper, fraiseuse à lamelles, aboteuse par entures multiples, kit de fixation de raboteuse, collecte de poussière, guide de coupe longitudinale biseautée, enroulement en hauteur, roues rétractables

Protégez votre audition

Utilisez toujours une protection appropriée de l'audition lorsque le bruit émis par l'outil dépasse 85dB.

LISTE DES PIÈCES

A. Table (1)

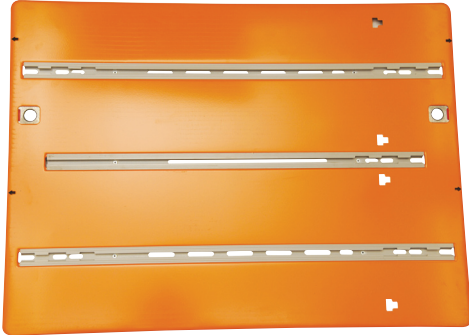

H. Guide de coupe transversale (1)



L. Châssis coulissant (1) J. Protection supérieure & support (1)

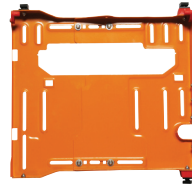

M. Poussoir guidé & doigts de poussée latérale

B. Panneau d'extrémité avant (1)



C. Panneau d'extrémité arrière (1)



G. Rapporteur (1)



K. Protection latérale (2)



F. Profilés de base (2)



D. Jambes (4)



E. Profilés de roulement (2)



N. Guides de coupe longitudinale biseautée (2)



I. Guide longitudinal (1)



SAC DE FIXATIONS



a. Goupille de verrouillage de jambes (4)



b. 16 boulons M8 (4)



c. Ecrou à embase M8 (4)



d. Rondelles 8mm (20)



e. Ecrou nyloc M8 (8)



f. 50 boulons M8 (8)



g. Support de poussoir (2)



h. Ecrou nyloc M5 (3)



i. 8 vis M5 (2)



j. 25 vis M5 (1)



k. Positionneurs de scie (4)



l. Boutons de fixation (4)



m. 40 vis M6 (4)



n. Ecrou à embase M6 (4)



o. Cames d'alignement de scie



p. Pied incliné (4)



q. Sangle de déclenchement (1)



r. Support de grille (2)



s. Serre-tube (1)



u. Etiquettes d'Indication d'échelle (1)



AVERTISSEMENTS. Lire toutes les consignes de sécurité et toutes les instructions. Si l'on ne respecte pas les avertissements et les consignes, il peut en résulter des chocs électriques, un incendie et/ou de graves blessures.

Conserver tous les avertissements et toutes les instructions pour pouvoir les consulter plus tard.

Le terme "outil électrique" dans les avertissements désigne votre outil électrique alimenté par l'alimentation secteur (cordon) ou par batterie (sans cordon).

1. Sécurité de la zone de travail

- a. Maintenez la zone de travail bien propre et bien éclairée. Les surfaces de travail encombrées ou sombres suscitent des accidents.
- b. N'utilisez pas d'outil électrique dans des atmosphères explosives, en présence de liquides inflammables, de gaz ou de poussière. Les outils électriques génèrent des étincelles pouvant enflammer la poussière ou les fumées.
- c. Maintenez à distance les enfants et les personnes présentes pendant le fonctionnement d'un outil électrique. La distraction en résultant peut vous faire perdre le contrôle de l'outil.

2. Sécurité électrique

- a. La prise mâle de l'outil électrique doit correspondre à la prise femelle de l'alimentation secteur. Ne modifiez jamais la prise mâle de l'outil. N'utilisez pas d'adaptateur de prise mâle avec des outils électriques raccordés à la terre. Des prises mâles non modifiées d'outil et des prises femelles d'alimentation secteur correspondantes diminueront le risque de choc électrique.
- b. Évitez le contact du corps avec des surfaces raccordées à la terre ou à la masse, comme des tuyaux, des radiateurs, des cuisinières et des réfrigérateurs. Le risque de choc électrique augmentera si votre corps est en contact avec la terre ou la masse.
- c. N'exposez pas d'outil électrique à la pluie ou à l'humidité. L'eau pénétrant dans un outil électrique augmentera le risque de choc électrique.

- d. N'exercez pas d'effort excessif sur le cordon. N'utilisez jamais le cordon pour transporter, tirer ou débrancher l'outil électrique. Maintenez le cordon loin de la chaleur, de l'huile, des arrêtes tranchantes ou des pièces mobiles. Des cordons endommagés ou embrouillés augmenteront le risque de choc électrique.
- e. Lorsque vous utilisez un outil électrique en extérieur, utilisez une rallonge faite pour une utilisation en extérieur. En utilisant un cordon adapté pour une utilisation en extérieur, vous réduirez le risque de choc électrique.
- f. Si vous devez impérativement utiliser un outil électrique à un emplacement humide, utilisez une alimentation électrique comportant une protection RCD (protection contre les courants résiduels). L'utilisation d'une protection RCD diminue le risque de choc électrique.

3. Sécurité personnelle

- a. Soyez vigilant, observez ce que vous faites et utilisez le bon sens pour faire fonctionner un outil électrique. N'utilisez pas un outil électrique si vous êtes fatigué ou sous l'influence de médicaments, d'alcool ou de drogue. Un moment d'inattention pendant l'utilisation d'un outil électrique peut entraîner de graves blessures.
- b. Utilisez des équipements de sécurité. Portez toujours une protection oculaire. Des équipements de sécurité comme masque anti-poussière, des chaussures de sécurité antidérapante, un casque dur ou une protection auditive utilisés dans des conditions appropriées diminueront le risque de blessure.
- c. Évitez les démarrages accidentels. Vérifiez que le commutateur est ouvert (off) avant de brancher l'outil. Si vous transportez un outil électrique en plaçant votre doigt sur le commutateur, ou si vous branchez un outil électrique dont le commutateur est fermé (on), vous augmenterez le risque d'accident.
- d. Enlevez la clé de réglage avant de mettre sous tension l'outil électrique. Une clé restant fixée sur un composant rotatif de l'outil électrique peut entraîner une blessure.

- e. Ne tenez pas l'outil à bout de bras. Gardez une bonne assise sur vos pieds et gardez un bon équilibre à tout moment. Ainsi, vous pourrez mieux maîtriser l'outil électrique dans des situations imprévues.
- f. Portez des vêtements appropriés. Ne portez pas de vêtement bouffant ou de bijou. Maintenez vos cheveux, vos vêtements et vos gants loin des pièces mobiles. Les vêtements mal ajustés (bouffants), les bijoux ou les cheveux longs peuvent être accrochés par des pièces mobiles.
- g. Si l'on utilise des dispositifs spéciaux se raccordant aux systèmes d'extraction et de collecte de poussière, vérifiez que ceux-ci sont bien raccordés et utilisés. L'utilisation de tels dispositifs peut diminuer les dangers concernant la poussière.

4. Utilisation et entretien de l'outil électrique

- a. N'utilisez pas l'outil électrique au-delà de sa puissance nominale. Utilisez un outil électrique ayant la puissance nominale correcte pour votre application. En utilisant un outil électrique ayant la puissance correcte pour le travail à exécuter, le travail sera exécuté mieux et de manière plus sûre.
- b. N'utilisez pas l'outil électrique si le commutateur ne peut pas être fermé et ouvert (on et off). Un outil électrique dont le commutateur ne peut pas être maîtrisé est dangereux et doit être réparé.
- c. Débranchez la prise mâle de l'outil de la prise femelle d'alimentation principale avant de procéder à des réglages, de remplacer des accessoires, ou de ranger l'outil. De telles mesures de sécurité diminueront le risque d'un démarrage accidentel de l'outil électrique.
- d. Rangez les outils électriques hors de portée des enfants, et interdisez l'utilisation de l'outil électrique aux personnes ne le connaissant pas ou ne connaissant pas ces instructions. Les outils électriques sont dangereux entre les mains de personnes non entraînées.
- e. Débranchez toujours votre outil électrique lorsque vous le laissez sans surveillance. De telles mesures préventives de sécurité diminuent le risque d'un démarrage accidentel de l'outil par des personnes non entraînées.

- f. Entretenez les outils électriques. Recherchez le mésalignement ou le grippage des pièces mobiles, la rupture de pièces, et d'autres conditions pouvant affecter le fonctionnement de l'outil. Si l'outil électrique est endommagé, faites-le réparer avant de l'utiliser. De nombreux accidents proviennent d'outils électriques mal entretenus.
- g. Maintenez les arrêtes de coupe bien aiguisées et propres. Les outils de coupe dont les arrêtes sont correctement entretenues risquent moins de gripper et sont plus faciles à maîtriser.
- h. Utilisez l'outil électrique, les accessoires, les scies, les forêts, etc., conformément à ces instructions et comme prévu pour le type particulier d'outil électrique, en tenant compte des conditions de travail et du travail à exécuter. L'utilisation d'un outil électrique pour des opérations autres que celles pour lesquelles il a été prévu peut entraîner des situations dangereuses.

5. Entretien

- a. Pour l'entretien de votre outil électrique, faites appel à un technicien qualifié n'utilisant que des pièces de rechange identiques. Ceci garantira le maintien de la sécurité de l'outil électrique.

SYMBOLES

PROTECTION DE L'ENVIRONNEMENT



Les appareils électriques usagés ne devraient pas être jetés avec les ordures ménagères. Veuillez recycler lorsqu'il existe des infrastructures de recyclage.

Consultez l'autorité locale ou le revendeur les plus proches de chez vous pour obtenir des conseils sur le recyclage.



Portez toujours des protections antibruit, des lunettes de sécurité et un masque à poussière.



Double isolation.



Instructions d'avertissement.



N'employez pas avant la visionnement et l'arrangement les pleines consignes d'utilisation



Consultez le DVD pour voir les instructions complètes.

INSTALLATION DE LA SCIE ÉLECTRIQUE TRITON 235MM

Installation du châssis coulissant

Installez le châssis coulissant (L) dans les profilés de roulement, le cliquet plastique rouge et les entretoises rouges étant placés le plus près possible du panneau avant (extrémité du boîtier de commutateur) et les brides étant en position haute. Faites pénétrer les deux roulements dans les fentes du profilé. Faites glisser le châssis vers le panneau arrière, et les autres roulements s'abaisseront. Pulvérisez dans les fentes du profilé du produit RP7 ou WD40 pour que le châssis coulisse régulièrement.

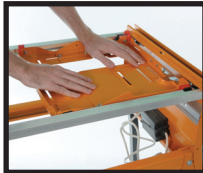

Installez les cames d'alignement de scie (o) par en dessous, en maintenant les bases dans les fentes rectangulaires pendant que vous les vissez (elles découpent leur propre filetage). Vérifiez que les lignes moulées en haut des cames sont dirigées vers le panneau arrière. Serrez doucement les vis.

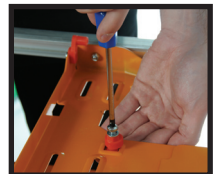
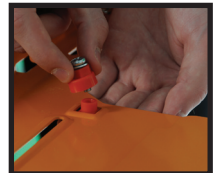

Installation des positionneurs et des boutons de scie

Installez la scie dans le châssis, les cames d'alignement étant placées dans les trous dans la plaque de base de la scie.

Cassez ou coupez les positionneurs de scie (k) et les boutons (l) pour les séparer de leur "arbre" de moulage, et coupez avec précaution les parties restantes à l'aide d'un couteau bien aiguisé. Installez les positionneurs de scie dans les fentes



indiquées en utilisant quatre vis à tête Philips (m) et des écrous à embase (n). Les arrêtes droites doivent être contre la plaque de base, mais avec un faible jeu par rapport à elle pour permettre le réglage final de la scie.

(Utilisez une lame spatule ou un morceau de carton ou de métal d'environ 1 mm d'épaisseur comme entretoise). Serrez à fond les vis.

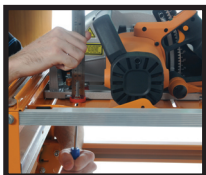

Vissez les boutons (ils découpent leur propre filetage) jusqu'à ce qu'ils grattent contre le bord supérieur de la plaque de base de la scie. Cette tension est suffisante pour maintenir la scie en position renversée pour le réglage final, tout en permettant de déplacer faiblement latéralement la scie à l'aide des cames d'alignement.

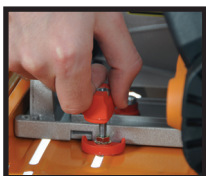

Vérifiez que la scie est solidement montée. Retournez le châssis coulissant, en engageant à nouveau les roulements dans les profilés.



Alignement de la scie

Positionnez le châssis à mi-distance entre les panneaux d'extrémité. Ajustez le guide près de la lame et verrouillez-le. Vérifiez que la lame est verticale en la comparant à la face du guide. Si nécessaire, dévissez l'écrou maintenant le dispositif de réglage angulaire de la lame, et réglez l'angle de la lame. Resserez l'écrou.



En utilisant la clé de la scie ou le serre-tube (s),



faites tourner les cames jusqu'à ce que les parties avant et arrière de la lame touchent juste le guide, lorsqu'il est sur la position 0mm. Une fois que la position obtenue est correcte, serrez les vis de came d'alignement.



Dévissez la poignée avant de la scie pour pouvoir accéder à la came avant. Abaissez la scie pour pouvoir accéder à la came arrière.

Fixation finale de la scie

Vérifiez deux fois la position de la scie en verrouillant maintenant le guide sur la position 0mm, et en essayant de faire tourner à la main la lame en sens inverse. Les dents doivent légèrement frotter contre la face du guide. Dans le cas contraire, répétez l'alignement ci-dessus.



Ceci est une étape très importante, car elle garantira que vos coupes sont précises, et que les échelles du guide sont précises, donc prenez le temps nécessaire.

Une fois que la position de la scie est satisfaisante, remettez en place les positionneurs de scie contre le bord de la plaque de base, de la manière suivante. Bloquez chaque bouton pour l'empêcher de tourner, et dévissez la vis d'un demi-tour. Enfoncez en place le positionneur de scie, et serrez à fond la vis.

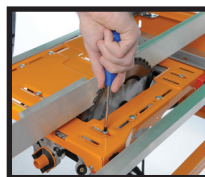

Faites tourner à nouveau la scie dans le sens correct, et dévissez les quatre boutons de deux tours.

Vérifiez que la scie ne peut pas se déplacer latéralement, et que toutes les vis sont bien serrées. Dévissez à nouveau les boutons, d'environ un tour, une fois qu'ils commencent à frotter sur la plaque de base.

La scie est maintenant réglée, et peut être utilisée à tout moment dans le cas d'une application portative; il suffit de dévisser chaque bouton d'un demi-tour et de soulever la scie verticalement. Si les positionneurs sont bien installés, la scie reviendra exactement au même emplacement à chaque fois.



Installation de la protection laterale

Faites glisser ensemble les deux sections de la protection latérale (K) pour qu'elles se placent entre les supports de pivot sur le châssis coulissant. Installez, sans les serrer, la vis courte à tête Philips (i) et un écrou Nyloc (h) pour les maintenir ensemble.

Installez les deux vis plus longues à tête Philips (j) et les écrous Nyloc à travers les supports de pivot et dans les brides de la protection. Serrez jusqu'à ce que la protection soit bien fixée, mais puisse encore pivoter. Enfin, serrez la vis maintenant ensemble les deux moitiés.



Installation de la sangle de declenchement

Avant d'installer la sangle de déclenchement (q), vérifiez toujours que la scie est  débranchée de l'alimentation électrique et que le commutateur sur le panneau avant du poste de travail est sur la position OFF (ouvert).

Enroulez la sangle de déclenchement (q) autour de la poignée, le côté fourré étant tourné vers l'extérieur. Faites passer la sangle à travers la boucle, jusqu'à ce que la boucle de sécurité ait passé à travers. Si votre scie comporte un bouton de déverrouillage de sécurité, appuyez sur ce bouton, et ensuite serrez la sangle jusqu'à ce qu'elle s'encliquette.

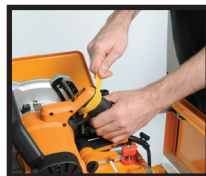

Enroulez l'extrémité libre de la sangle autour de la poignée.



Sur la plupart des scies, on peut faire coulisser la sangle pour la serrer ou la desserrer, sans la défaire à chaque fois.

Ne laissez pas la sangle de déclenchement verrouillée en permanence. Une fois que vous avez terminé le travail de la journée, libérez la sangle et laissez le ressort se détendre dans le déclencheur.

Installation de la table

Retournez le châssis coulissant. Positionnez-le à mi-distance entre les panneaux d'extrémité. La partie avant de la scie doit être tournée vers le panneau avant (extrémité du boîtier de commutateur).

Abaissez la table (A) sur la lame, les quatre fentes (T) étant à proximité du panneau arrière. Alignez les flèches sur les bords de la table avec les aiguilles d'échelle en haut des panneaux d'extrémité. Enfoncez les verrous de la table sur la position LOCK (verrouillage). Les indicateurs rouges ne



UNLOCKED



LOCKED

seront plus visibles lorsque les verrous sont complètement engagés.

Passez par en dessous et poussez le châssis coulissant vers le panneau arrière jusqu'à ce que le cliquet rouge s'encliquette en position et verrouille le châssis sous la table.



Installation de la protection supérieure et de son support

Dévissez le bouton sur la protection supérieure (J) pour libérer le support de la protection de la position qu'il a pour le transport.

Installez le support dans la fente centrale de la table, en utilisant les découpages à l'extrémité.

Vérifiez que la lame est réglée sur sa profondeur maximum, puis positionnez le support à environ 12mm derrière la lame, et verrouillez-le en appuyant sur le levier de verrouillage.



Lubrifiez le passage d'entrée s'il s'agit d'un ajustement serré.

Vérifiez que le support de la protection est perpendiculaire à la table, et si nécessaire ajustez-le en appuyant de manière uniforme avec votre main ou un morceau de bois.



Appuyez légèrement 2 morceaux de bois droits contre la lame. Le support de la protection supérieure doit se placer entre les morceaux de bois. Dans le cas contraire, vous devez modifier légèrement la position de la scie. Pour cela, vous devez disposer d'une lame à saigner très mince (largeur de coupe 2,0 - 2,2mm).



Installez et abaissez la protection. Faites tourner la lame à la main avant de brancher l'alimentation électrique afin de vous assurer que la lame ne touche rien.



! Vérifiez toujours que la lame est à la hauteur maximum, que la protection est installée, et que la table est verrouillée sur les panneaux d'extrémité avant de brancher l'alimentation électrique secteur. Vérifiez que les dents de votre lame sont tournées dans la même direction que les symboles gravés sur la protection. Dans le cas contraire, vous avez mal installé la lame sur votre scie.

Branchement de l'alimentation électrique

Vérifiez que le commutateur est ouvert (position OFF), raccordez la scie dans le boîtier de commutateur, et amenez le courant électrique dans le boîtier du commutateur à l'aide d'un cordon de capacité correcte.

Appuyez sur le commutateur blanc avec votre doigt pour mettre sous tension (position ON). Tapez sur la plaque butée avec votre main ou le coude pour ouvrir le commutateur (position OFF).



Allumez et éteignez et observez la lame. Si elle oscille latéralement au démarrage, ceci indique une usure de l'arbre de la scie, ou un jeu excessif dans les supports entre le moteur et la plaque de base.

Si la lame vibre fortement à la vitesse maximum ou au ralentissement, soit la lame est gauchie, soit elle n'est pas correctement en place sur l'arbre. Vérifiez la rectitude de la lame à l'aide d'une règle, vérifiez l'ajustement des rondelles réductrices de l'arbre, et vérifiez qu'il n'y a pas de dépôt de résidu ou de sciure sur

GARANTIE

Pour enregistrer votre garantie, visitez notre site internet à www.tritontools.com* et entrez vos détails. Nous ajouterons vos détails à notre liste d'abonnés (sauf indication contraire) afin de vous tenir informés de nos nouveautés. Les détails fournis ne seront communiqués à aucune tierce partie.

INFORMATIONS D'ACHAT

Date d'achat : ___ / ___ / ___

Modèle : WCA201

Numéro de série : _____

(indiqué sur la plaque du moteur)

Conservez votre reçu, il vous servira de preuve d'achat.

Triton Precision Power Tools garantit à l'acheteur de ce produit que toute pièce présentant un vice de matériau ou de fabrication dans les 12 MOIS suivants la date d'achat d'origine, sera réparée ou remplacée, à sa discrétion.

Cette garantie ne s'applique pas à l'usage commercial et ne couvre pas l'usure normale ni les dommages consécutifs à un accident, une utilisation incorrecte ou abusive.

* Enregistrement sur le site dans les 30 jours*

Acceptation des conditions.

Cela n'affecte pas vos droits légaux.

Dieses Produkt verfügt über eine Reihe einzigartiger Funktionen. Bitte lesen Sie diese Bedienungsanleitung auch dann durch, wenn Sie bereits mit diesem Werk Tisch vertraut sind. Nur so werden Sie diesen Werk Tisch optimal nutzen können. Bewahren Sie diese Bedienungsanleitung in Reichweite auf und sorgen Sie dafür, dass alle Benutzer dieses Werkzeugs die Anweisungen vollständig gelesen und verstanden haben.

INHALT

Spezifikation	27
Teileliste	28
Sicherheit	29
Symbole	31
Montieren der Triton Säge	31
Garantie	35
Konformitätserklärung	54

SPEZIFIKATION

Teil-Nr.:	WCA201
Geeignet für:	Die meisten Kreissägen (185mm - 235mm)
Schnittarten:	Längsschnitte, Gehrungen, 45° Längs-/Schrägschnitte, Querschnitte, Quer-/Schrägschnitte, Kapp-/Gehrungsschnitte
Längsschnitte:	0 - 620mm
Querschnitte:	Breiten bis zu 500mm
Größe aufgeklappt:	ca. 900mm x 600mm x 1300mm
Größe zusammengeklappt:	ca. 350mm x 440mm x 1000mm
Standardausrüstung:	3-seitiger Winkelmesser (Verstellung 45° auf 0° auf 45°), Parallelanschlag mit 45° Schrägseite, Klappbeine, Schaltkasten mit Sicherheitsabschaltung, Blattschutz mit Staubabführung und Rückschlagschutz, Schnellspannelemente, Seitenschutz, Queranschlag, Sicherheitsschieber und seitliches Andrückelement.
Zubehör:	Ausziehtisch, oberfräsentisch, stichsägenzubehör, flachdübelfräse, zinkenfräse, hobelmaschinenzubehör, staubfang, längs-/ schräg- (Winkel-) führung, höhenverstellungssystem, ratsatz

Gehörschutz

Es muss stets ein passender Gehörschutz benutzt werden, wenn der Lärm eines Gerätes mehr als 85 dB beträgt.

TEILELISTE

A. Tisch (1)

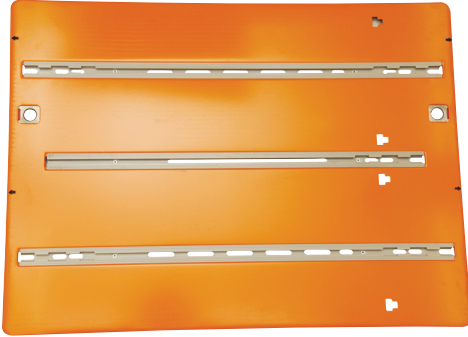

B. Vorderes Feld (1)



C. Hinteres Feld (1)



F. Basisprofile (2)



E. Lagerprofile (2)



I. Parallelanschlag (1)



H. Queranschlag (1)



L. Schiebesechleifen (1)

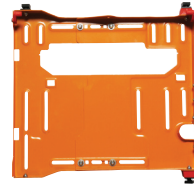

J. Oberschutz & Schutzhalterung (1)



M. Geführter Schieber & seitlicher Andrückfinger

G. Winkelmesser (1)



K. Seitenschutz (2)



N. Parallel- / Winkelführungen (2)



D. Beine (4)



BEFESTIGUNGSMITTEL

- a. Beinarretierungsstift (4)
- b. M8 x 16 Schraube (4)
- c. M8 Flanschmutter (4)
- d. 8 mm Unterlegscheibe (20)
- e. M8 Nyloc-Mutter (8)
- f. M8 x 50 Schraube (8)
- g. Schieberhänger (2)

- h. Ecrou nyloc M5 (3)
- i. 8 vis M5 (2)
- j. 25 vis M5 (1)
- k. Positionneurs de scie (4)
- l. Bouffons de fixation (4)
- m. 40 vis M6 (4)
- n. Ecrou à embase M6 (4)
- o. Sah Ausrichtungsnocken

- p. Pied incliné (4)
- q. Sangle de déclenchement (1)
- r. Support de grille (2)
- s. Serre-tube (1)
- u. Etiquettes d'Indication d'échelle (1)



WARNUNG: Sämtliche Sicherheitshinweise und Anweisungen müssen gelesen werden. Bei Nichtbeachtung der Sicherheitshinweise und Anweisungen besteht die Gefahr von elektrischem Schock, Feuer und/oder schwerwiegenden Verletzungen.

Sämtliche Sicherheitshinweise und Anweisungen zu späteren Nachschlügen aufbewahren.

Der Begriff Elektrowerkzeug steht für netzbetriebenes (mit Netzkabel ausgestattetes) Elektrowerkzeug oder batteriebetriebenes (kabelloses) Elektrowerkzeug.

1. Sicherer Arbeitsbereich

- a. Der Arbeitsbereich muss stets sauber und gut beleuchtet sein. Unaufgeräumte und dunkle Arbeitsbereiche können zu Unfällen führen.
- b. Elektrowerkzeuge dürfen nicht benutzt werden, falls eine Explosionsgefahr durch brennbares Material, entzündbare Flüssigkeiten und Gase oder explosiven Staub besteht. Elektrowerkzeuge produzieren Funken, welche explosive Atmosphären entzünden können.
- c. Kinder und andere Personen müssen während der Arbeit mit einem Elektrowerkzeuge ferngehalten werden. Eine Ablenkung von der Arbeit kann leicht dazu führen, dass man die Kontrolle über das Werkzeug verliert.

2. Elektrische Sicherheit

- a. Die Stecker der Elektrowerkzeuge müssen den örtlichen Steckdosen entsprechen. Stecker dürfen auf keinen Fall modifiziert werden. Bei geerdeten Elektrowerkzeugen dürfen keine Adapterstecker verwendet werden. Unmodifizierte Stecker und übereinstimmende Steckdosen reduzieren die Gefahr eines elektrischen Schocks.
- b. Körperlicher Kontakt mit geerdeten Teilen, wie Rohre, Heizkörper, Öfen und Kühlschränken, muss vermieden werden. Wenn Ihr Körper mit der Erde kurz geschlossen ist, besteht eine erhöhte Gefahr eines elektrischen Schocks.
- c. Elektrowerkzeuge dürfen nicht unter feuchten oder nassen Bedingungen eingesetzt oder Regen ausgesetzt werden. Falls in ein Elektrowerkzeug Wasser eindringt, erhöht sich die Gefahr eines elektrischen Schocks.

- d. Das Kabel nicht für andere Zwecke missbrauchen. Das Elektrowerkzeug darf auf keinen Fall am Kabel getragen, gezogen oder ausgesteckt werden. Das Kabel von Hitzequellen, Öl, scharfen Kanten oder beweglichen Teilen fernhalten. Durch beschädigte oder verhedderte Kabel erhöht sich die Gefahr eines elektrischen Schocks.
- e. Für die Benutzung eines Elektrowerkzeugs im Freien muss ein für den Einsatz im Freien geeignetes Verlängerungskabel verwendet werden. Die Benutzung eines für den Einsatz im Freien geeigneten Kabels reduziert die Gefahr eines elektrischen Schocks.
- f. Falls es sich nicht vermeiden lässt, ein Elektrowerkzeug in feuchter Umgebung zu benutzen, muss ein Fehlerstromschutzschalter (FI-Schalter) eingesetzt werden. Die Benutzung eines Fehlerstromschutzschalters reduziert die Gefahr eines elektrischen Schocks.

3. Persönliche Sicherheit

- a. Halten Sie Ihre Aufmerksamkeit aufrecht, achten Sie darauf, was Sie tun, und benutzen Sie Ihren gesunden Menschenverstand, wenn Sie ein Elektrowerkzeug benutzen. Benutzen Sie auf keinen Fall ein Elektrowerkzeug, wenn Sie müde sind oder unter dem Einfluss von Drogen, Alkohol oder Medikamenten stehen. Schon die kleinste Unachtsamkeit bei der Benutzung eines Elektrowerkzeugs kann zu ernsthaften Verletzungen führen.
- b. Persönliche Sicherheitsausrüstungen benutzen. Beim Arbeiten stets einen Augenschutz verwenden. Sicherheitsausrüstungen wie Staubmaske, rutschfeste Sicherheitsschuhe, Schutzhelm oder Gehörschutz reduzieren die Gefahr von Verletzungen.
- c. Darauf achten, dass das Gerät nicht unbeabsichtigt eingeschaltet wird. Sicherstellen dass der Schalter ausgeschaltet ist, bevor der Stecker eingesteckt wird. Das Tragen von Elektrowerkzeugen mit einem Finger am Schalter oder Anstecken am Netz bei eingeschaltetem Schalter können zu Unfällen führen.

- d. Bevor das Elektrowerkzeug eingeschaltet wird, müssen sämtliche Werkzeuge wie Stellschlüssel oder Spanschlüssel entfernt werden. Falls ein Spanschlüssel oder Stellschlüssel am rotierenden Teil des Elektrowerkzeugs angebracht bleiben, kann es zu Verletzungen kommen.
- e. Nicht zu weit vorgebeugt arbeiten. Stets für einen sicheren Stand sorgen. Dadurch wird eine bessere Kontrolle des Elektrowerkzeugs in unerwarteten Situationen gewährleistet.
- f. Ziehen Sie sich richtig an. Tragen Sie keine lose Kleidung oder Schmuck. Halten Sie Haare, Kleidung und Handschuhe von beweglichen Teilen fern. Lose Kleidung, Schmuck oder lange Haare können sich in beweglichen Teilen verfangen.
- g. Falls die Möglichkeit für den Anschluss von Staubabsaugung und Staubfang besteht, muss dafür gesorgt werden, dass diese angeschlossen und ordnungsgemäß benutzt werden. Durch die Benutzung dieser Einrichtungen werden mögliche Gefahren aufgrund von Staub reduziert.

4. Einsatz und Pflege des Elektrowerkzeugs

- a. Am Elektrowerkzeug nicht zu hohe Kraft aufwenden. Benutzen Sie das für den jeweiligen Zweck korrekte Elektrowerkzeug. Mit dem korrekten Elektrowerkzeug kann die gewünschte Arbeit besser, sicherer und konstruktionsgemäß durchgeführt werden.
- b. Das Elektrowerkzeug darf nicht benutzt werden, wenn es nicht mit dem Schalter ein- und ausgeschaltet werden kann. Ein Elektrowerkzeug, das nicht mit dem Schalter ein- und ausgeschaltet werden kann, stellt eine Gefahr dar.
- c. Bevor Sie am Werkzeug irgendwelche Einstellungen durchführen, Zubehör wechseln oder das Elektrowerkzeug einlagern, muss das Netzkabel vom Netz getrennt werden. Durch diese Vorsichtsmaßnahme wird die Gefahr reduziert, dass das Elektrowerkzeug unbeabsichtigt eingeschaltet wird.
- d. Elektrowerkzeuge müssen, wenn sie nicht benutzt werden, vor dem Zugriff durch Kinder oder andere Personen, die mit dem Elektrowerkzeug bzw. diesen Anleitungen nicht vertraut sind, geschützt werden.

Elektrowerkzeuge stellen in den Händen von unerfahrenen und ungeschulten Personen eine Gefahr dar.

- e. Wenn Sie Ihr Elektrowerkzeug unbeaufsichtigt lassen, muss der Netzstecker stets vom Netz getrennt werden. Durch diese Vorsichtsmaßnahme wird die Gefahr reduziert, dass das Elektrowerkzeug unbeabsichtigt eingeschaltet wird.
- f. Halten Sie Elektrowerkzeuge in gutem Wartungszustand. Überprüfen Sie es auf Fehlausrichtungen oder Hängen bleiben von beweglichen Teilen, Bruch von Teilen oder andere Zustände, die den Betrieb des Elektrowerkzeugs beeinträchtigen könnten. Falls Beschädigungen vorliegen, muss das Elektrowerkzeug repariert werden, bevor es wieder zum Einsatz kommt. Viele Unfälle sind auf schlecht gewartete Elektrowerkzeuge zurückzuführen.
- g. Schneidwerkzeuge müssen in einem geschliffenen und sauberen Zustand gehalten werden. Mit korrekt gewarteten Schneidwerkzeugen mit scharfen Schnittflächen ist es weniger wahrscheinlich, dass diese hängen bleiben oder außer Kontrolle geraten.
- h. Das Elektrowerkzeug, Zubehör und die Werkzeugaufsätze usw. müssen in Übereinstimmung mit dieser Anleitung und dem Zweck des jeweiligen Elektrowerkzeugs eingesetzt werden und die jeweiligen Arbeitsbedingungen und durchzuführenden Arbeiten sind zu berücksichtigen. Eine zweckfremde Benutzung des Elektrowerkzeugs kann zu gefährlichen Situationen führen.

5. Service

- a. Lassen Sie Ihr Elektrowerkzeug von einer qualifizierten Fachkraft warten. Für die Wartung dürfen nur identische Ersatzteile verwendet werden. Dadurch wird die Erhaltung der Sicherheit des Elektrowerkzeugs gewährleistet.

SYMBOLE

UMWELTSCHUTZ



Elektroprodukte sollten nicht mit dem Haushaltsmüll entsorgt werden. Bitte, recyceln, wo die Möglichkeit besteht.

Lassen Sie sich von Ihrer örtlichen Behörde oder dem Händler hinsichtlich des Recyclens beraten.



Immer Ohren-, Augen- und Atemschutz tragen.



Doppelt isoliert.



Anweisung - Warnhinweis



Verwenden sie nicht vor betrachtung und verständnis die vollen bedienungsanleitungen



Eine vollständige Anleitung befindet sich auf der DVD

MONTIEREN DER TRITON 235-MM-SÄGE

Montieren des schiebeschlittens

Setzen Sie den Schiebeschlitten (L) in die Lagerprofile mit der roten Kunststoffarretierung und den roten Lagerdistanzelementen zum vorderen Feld (Schaltkastenende) und den Flanschen nach oben gerichtet. Geben Sie zwei Lager in die Profilaussparungen. Schieben Sie den Schlitten zum hinteren Feld. Die anderen Lager werden hineinfallen.



Sprühen Sie RP7 oder WD40 auf die Profile, um eine reibungslose Bewegung des Schlittens zu gewährleisten.

Montieren der triton säge

Trennen Sie Ihre Säge vom Netz. Überprüfen Sie, ob das Sägeblatt auf 0° und volle Schnitttiefe eingestellt ist.

Montieren Sie die Sägeführungsnocke (o) von unten, dabei die Unterseiten in den rechtwinkligen Schlitzten halten und



hineinschrauben. (Die Gewinde sind selbstschneidend.) Darauf achten, dass die auf den Nocken oben angeformten Linien zum hinteren Feld weisen. Die Schrauben festziehen, bis sie leicht greifen.



Montieren der zentriereelemente und knöpfe

Die Säge am Schlitten aufsetzen, mit den Führungsnocken in den Löchern an der Sägeunterseite.

Die Sägezentriereelemente (k) und Knöpfe (l) ausbrechen oder ausschneiden und etwaige Reste mit einem scharfen Messer sorgfältig entfernen. Die Sägezentriereelemente in den gezeigten

Schlitzten mit 4 Kreuzkopfschrauben (m) und Flanschmutter (n) befestigen. Die geraden Kanten müssen zur Grundplatte gerichtet sein, aber leicht davon entfernt sein, um die Endjustierung der Säge zu ermöglichen.



(Benutzen Sie als Abstandshalter eine Spachtel oder Karton oder Blech mit einer Stärke von 1 mm.) Die Schrauben kräftig anziehen.

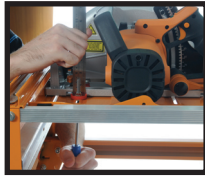

Die Knöpfe aufschrauben (die Gewinde sind selbstschneidend), bis sie die Oberkante der Sägegrundplatte knapp berühren. Dies genügt, um die Säge verkehrt herum zu halten, um die Endjustierung vorzunehmen, die Säge kann aber mit den Führungsnocken immer noch seitlich verschoben werden.



Vergewissern Sie sich, dass die Säge sicher montiert ist. Drehen Sie den Schiebeshlitten um, sodass die Lager in den Profilen wieder eingreifen.



Ausrichten der säge

Positionieren Sie den Schlitten in der Mitte zwischen den Endfeldern. Verstellen Sie den Anschlag zum Sägeblatt hin und arretieren Sie ihn. Durch Vergleich mit der Anschlagfläche sicherstellen, dass das Sägeblatt vertikal ausgerichtet ist. Gegebenenfalls die Mutter, durch welche der Sägeblattwinkel-versteller fixiert ist, lösen und den Sägeblattwinkel verstellen. Die Mutter wieder festziehen.



Mit Spannschlüssel oder Rohrschlüssel



(s) die Nocken drehen, bis Vorderseite und Rückseite des Sägeblattes knapp am Anschlag anliegen, das heißt bei 0 mm Abstand. Wenn Sie mit der Stellung zufrieden sind, die Schrauben für die Führungsnocke festziehen.



Den vorderen Griff der Säge abschrauben, um besseren Zugang auf die vordere Nocke zu erhalten. Das Sägeblatt senken, um Zugang zur hinteren Nocke zu erhalten.

Abschliessendes festspannen der säge

Den Anschlag bei 0 mm arretieren und versuchen, das Sägeblatt von Hand rückwärts zu drehen, um die Stellung der Säge noch einmal zu kontrollieren. Die Zähne sollten leicht an der Anschlagfläche kratzen. Falls nicht, den oben beschriebenen Vorgang wiederholen.



Dieser Schritt ist besonders wichtig, weil damit sichergestellt wird, dass die Säge genau schneidet und die Anschlagsskalen genau sind. Lassen Sie sich daher dafür Zeit.

Wenn Sie mit der Stellung der Säge zufrieden sind, können die Zentrierelemente wieder wie folgt fest an der Kante der Grundplatte positioniert werden. Jeden Knopf gegen Drehen sichern und die Schraube ungefähr um eine halbe bis zu einer vollen Drehung lösen. Sägezentrierelement

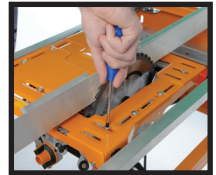

in die Position drücken und die Schraube fest anziehen.

Säge wieder mit dem richtigen Ende oben drehen und die vier Knöpfe um ein paar Umdrehungen lösen. Kontrollieren, dass sich die Säge nicht in seitlicher Richtung bewegen kann und alle Schrauben fest angezogen sind. Die Knöpfe wieder festdrehen, bis sie an der Grundplatte leicht ankratzen und dann eventuell um eine weitere Drehung.

Die Säge ist somit fertig eingerichtet und kann jederzeit im Handbetrieb eingesetzt werden, indem die Knöpfe um eine halbe Drehung gelöst und die Säge in gerader Linie gehoben wird. Wenn die Zentrierelemente korrekt angebracht sind, wird die Säge stets wieder die korrekte Stellung einnehmen.



Montieren des seitenschutzes

Die beiden Teile des Seitenschutzes (K) zusammenschieben, bis sie zwischen die Gelenkhalterungen am Schiebeschlitten passen. Die kurze Kreuzkopfschraube (i) einführen und eine Nyloc-Mutter (h) anbringen, um die beiden Teile zusammenzuhalten.

Mit den beiden längeren Kreuzkopfschrauben (j) und den Nyloc-Muttern die Gelenkhalterungen und Schutzflansche verbinden. Festziehen, bis der Schutz fest angebracht ist, aber noch frei drehbar ist. Zum Schluss die Schraube, mit der die beiden Hälften zusammengehalten werden, festziehen.



Montieren des triggerbandes

 Vor dem Montieren des Triggerbandes (q) muss sichergestellt werden, dass die Säge vom Netz getrennt ist und der Schalter am vorderen Feld des Workcenters in der AUS-Stellung ist.

Das Triggerband (q) um den Handgriff wickeln, mit der haarigen Seite nach außen.

Das Band durch die Schnalle führen, bis die Sicherheitsschlaufe durch ist. Falls Ihre Säge einen Sicherheits-schaltknopf besitzt, diesen Drücken und dann das Band spannen, bis der Trigger aktiviert wird.

Das freie Ende des Bandes um den Handgriff wickeln.

Bei den meisten Sägen kann das Band ohne es zu öffnen auf den Sägetrigger geschoben und von diesem heruntergezogen werden.

Lassen Sie das Triggerband nicht permanent in geschlossener Stellung. Wenn Sie mit der Arbeit für den Tag fertig sind, das Band lösen, sodass sich die Feder im Trigger entspannen kann.

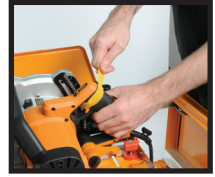

Montieren des tisches

Den Schiebeschlitten umdrehen. Den Schlitten etwa in der Mitte zwischen den Endfeldern positionieren. Die Vorderseite der Säge muss zum vorderen Feld (Schaltkastenende) gerichtet sein.

Den Tisch (A) über das Sägeblatt senken, mit den vier T-Schlitten dem hinteren Feld zugewendet. Die Pfeile an den Tischkanten mit den Skalenzeigern an der Oberseite der Endfelder ausrichten. Die Tischarretierungen in die GESPERRTE



UNLOCKED



LOCKED

Stellung (LOCK) drücken. Die roten Marken werden nicht mehr zu sehen sein, wenn die Arretierungen voll eingerastet sind.

Nach unten greifen und den Schlitten zum hinteren Feld schieben, bis die rote Arretierung einrastet und den Schlitten unter dem Tisch arretiert.



Montieren von Oberschutz & Halterung

Den Knopf am Oberschutz (J) lösen, um die Schutzhalterung von der gelieferten Stellung zu entfernen. Die Halterung unter Einsatz der Aussparungen am Ende am mittleren Tischschlitz anbringen.

Sicherstellen, dass das Sägeblatt auf die maximale Schnitttiefe eingestellt ist, dann die Halterung etwa 12mm hinter dem Sägeblatt positionieren und durch Herunterdrücken des Arretierhebels arretieren.



Gegebenenfalls die Eintrittsstelle schmieren.

Überprüfen, ob die Schutzhalterung rechtwinklig zum Tisch steht. Bei Bedarf durch Drücken mit der Hand oder einem Holzstück verstellen.



Zwei gerade Holzstücke leicht gegen das Sägeblatt halten. Die Oberschutzhalterung sollte zwischen die beiden Stücke passen.



Falls nicht, muss die Sägestellung leicht justiert werden. Dies ist nur wahrscheinlich, wenn Sie ein Sägeblatt mit sehr schmaler Schnittfugenbreite (2,0 - 2,2 mm) haben.



Schutz montieren und senken. Das Sägeblatt von Hand drehen, bevor Sie die Säge am Netz anschließen, um sicherzustellen, dass es nichts berührt.

 Vor dem Einschalten muss stets sichergestellt werden, dass das Sägeblatt voll angehoben, der Schutz montiert und der Tisch an den Endfeldern arretiert ist. Überprüfen, ob die Zähne am Sägeblatt in die gleiche Richtung zeigen wie die am Schutz eingezätzten Symbole. Falls dies nicht der Fall ist, haben Sie das Sägeblatt an Ihrer Säge falsch montiert.

Anschliessen am Netz

Sicherstellen, dass der Schalter ausgeschaltet ist. Die Säge am Schaltkasten anstecken und über ein entsprechend bemessenes Verlängerungskabel den Schaltkasten mit dem Netz verbinden.

Den weißen Schalter mit Ihrem Finger drücken, um die Säge einzuschalten. Die Abschaltplatte mit der Hand oder dem Knie antippen, um die Säge auszuschalten.



Die Säge ein- und ausschalten und das Sägeblatt beobachten. Falls es beim Einschalten flattert, ist die Blattaufnahme abgenutzt oder die Befestigungen zwischen Motor und Grundplatte sind zu locker.

Falls das Blatt bei voller Drehzahl oder Verlangsamung zu stark schwingt, ist es entweder verbogen oder es sitzt nicht richtig in der Blattaufnahme. Überprüfen Sie die Flachheit des Sägeblattes mit einem Lineal und die Passung von Unterlegscheiben an der Blattaufnahme und prüfen Sie, ob sich an Blattaufnahme oder Unterlegscheiben Harz oder Sägemehl angesammelt hat.

Wenn sich die Drehzahl von Sägeblättern verlangsamt ist, meist ein wenig Flattern zu bemerken. Dadurch wird das Schneiden jedoch nicht beeinträchtigt.

GARANTIE

Zur Registration Ihrer Garantie besuchen Sie bitte unsere Website www.tritontools.com* und geben Sie dort Ihre Details ein.

Diese werden dann in unserer Postversandliste aufgenommen (wenn nicht anders angegeben), damit wir Sie über zukünftige Neueinführungen informieren. Ihre Details werden keinen dritten Parteien zugänglich gemacht.

KAUFINFORMATION

Datum des Kaufs: ___ / ___ / ___

Modell: WCA201

Seriennummer: _____
(Auf dem Motortypenschild)

Behalten Sie Ihren Beleg als Kaufnachweis.

Triton Precision Power Tools garantiert dem Käufer dieses Produkts, dass Triton, wenn sich Teile innerhalb von 12 MONATEN ab Datum des Originalkaufs aufgrund defekter Materialien oder unzulänglicher Arbeitsausführung als defekt erweisen, das defekte Teil nach eigenem Ermessen entweder reparieren oder ersetzen wird.

Diese Garantie erstreckt sich nicht auf kommerzielle Verwendung oder normalen Verschleiss oder Schäden infolge von Unfall, Missbrauch oder unsachgemäßem Gebrauch.

* Registrieren Sie sich online innerhalb von 30 Tagen.

Bedingungen gelten.

Ihre gesetzlich festgelegten Rechte werden hierdurch nicht beeinträchtigt.

Questo prodotto è dotato di diverse soluzioni esclusive che potrebbero essere una novità anche per coloro che hanno una buona conoscenza del banco da lavoro. Per essere sicuri di utilizzare al meglio il potenziale del dispositivo si raccomanda pertanto di leggere a fondo questo manuale.

Conservare il manuale in modo che sia sempre a portata di mano e accertarsi che tutti gli operatori del dispositivo lo abbiano letto e che abbiano capito a pieno le relative istruzioni.

INDICE

Caratteristiche tecniche	36
Lista dei pezzi	37
Sicurezza	38
Simboli	40
Montaggio della sega Triton	40
Garanzia	44
EC Dichiarazione di conformità	54

CARATTERISTICHE TECNICHE

Modello:	WCA201
Adatto a:	Gran parte delle seghe circolari (185mm - 235mm)
Taglio:	longitudinale, quartabuono, longitudinale inclinato a 45°, trasversale, trasversale inclinato, obliquo inclinato
Capacità taglio longitudinale:	0 - 620mm
Capacità taglio trasversale:	fino a 500mm di larghezza
Dimensioni utensile aperto:	900mm x 600mm x 1300mm circa
Dimensioni utensile ripiegato:	350mm x 440mm x 1000mm circa
Caratteristiche standard:	goniometro a 3 vie (regolazione da 45° a 0° a 45°), guida parallela con piano inclinato a 45°, gambe pieghevoli, scatola di commutazione con dispositivo di arresto di sicurezza, protezione per la lama con bocchetta di aspirazione trucioli e protezione contro i contraccolpi, fissaggio sega ad aggancio rapido, protezione laterale sega, guida taglio trasversale, spingipezzo e dente spingitore laterale
Accessori opzionali:	banco scorrevole di prolunga, banco per fresatrice verticale, kit per seghetto alternativo, fresatrice per linguette, fresa per finger joint, Kit di montaggio pialletto, sistema di raccolta trucioli, guida per il taglio longitudinale inclinato, regolazione dell'altezza della lama, ruote retrattili

Proteggere l'udito

Indossare sempre adeguate protezioni per le orecchie quando il rumore dell'utensile supera gli 85 dB.

LISTA DEI PEZZI

A. Banco (1)

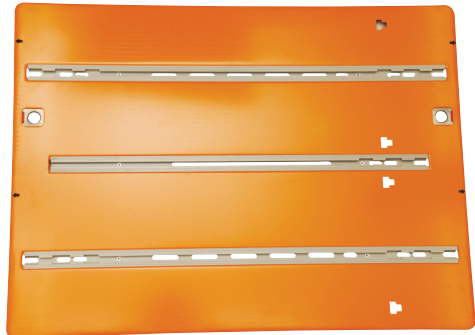

H. Guida taglio trasversale (1)



B. Pannello anteriore (1)



C. Pannello posteriore (1)



L. Telaio a slitta (1)



J. Protezione superiore e supporto protezione (1)

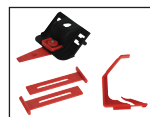

M. Spingipezzo guidato e dente spingitore laterale

F. Canali di base (2)



G. Goniometro (1)



K. Protezione laterale (2)



E. Canali cuscinetti (2)



N. Guide inclinazione guida parallela (2)



I. Guida parallela (1)



D. Gambe (4)



BUSTA PRINCIPALE ELEMENTI DI FISSAGGIO



a. Perno di arresto gambe (4)



b. Bulloni M8 x 16 (4)



c. Dado flangia M8 (4)



d. Rondella 8mm (20)



e. Dado nyloc M8 (8)



f. Bulloni M8 x 50 (8)



g. Staffa spingipezzo (2)



h. Dado nyloc M5 (3)



i. Viti M5 x 8 (2)



j. Viti M5 x 25 (1)



k. Localizzatori della sega (4)



l. Pomelli di serraggio (4)



m. Viti M6 x 40 (4)



n. Dado flangia M6 (4)

o. Camme di allineamento della sega



p. Piede angolato (4)



q. Cinghietta di innesto (1)



r. Staffa guida (2)



s. Chiave a tubo (1)



u. Etichette scala graduata (1)

ISTRUZIONI PER LA SICUREZZA

AVVERTENZA. Leggere tutte le avvertenze sulla sicurezza e tutte le istruzioni. La non osservanza delle avvertenze e delle istruzioni può causare scosse elettriche, incendi e/o lesioni gravi.

Conservare tutte le avvertenze e le istruzioni per la consultazione in qualsiasi momento.

Il termine "elettroutensile" nelle seguenti avvertenze si riferisce sia agli utensili alimentati con corrente di rete (dotati di cavo di alimentazione) che ai dispositivi a batteria (cordless).

1. SICUREZZA DELL'AREA DI LAVORO

- a. Mantenere l'area di lavoro pulita e adeguatamente illuminata. Gli incidenti sono più comuni nelle aree poco illuminate e disordinate.
- b. Non usare gli elettroutensili in presenza di atmosfere esplosive, come liquidi, gas e polveri infiammabili. Gli elettroutensili producono scintille che potrebbero accendere i gas, le polveri o i fumi.
- c. Tenere altre persone, e soprattutto i bambini, a distanza di sicurezza quando si utilizza un elettroutensile. Un attimo di distrazione è sufficiente a far perdere il controllo dell'utensile all'operatore.

2. Sicurezza elettrica

- a. Le spine delle macchine utensili devono essere compatibili con le prese di corrente. Non modificare in alcun modo la spina dell'elettroutensile. Non usare adattatori con gli elettroutensili dotati di collegamento di messa a terra (isolati). L'uso delle spine originali non modificate e delle prese corrispondenti ridurrà il rischio di scosse elettriche.
- b. Evitare il contatto del corpo con le superfici collegate alla messa a terra come i tubi, i radiatori, le cucine e i frigoriferi. Il rischio di scosse elettriche è maggiore quando il proprio corpo è collegato a massa.
- c. Non esporre gli elettroutensili alla pioggia e non lasciarli in ambienti umidi o bagnati. L'ingresso dell'acqua in una macchina utensile aumenta il rischio di scosse elettriche.
- d. Non usare il cavo in modo improprio. Non afferrare mai il cavo per trasportare o tirare l'utensile o per staccarlo dalla presa di corrente. Tenere il cavo lontano da

fondi di calore, benzina e sostanze affini, bordi appuntiti o parti in movimento. I cavi danneggiati o attorcigliati aumentano il rischio di scosse elettriche.

- e. Quando si usa un elettroutensile all'esterno, usare cavi di prolunga omologati per l'uso in ambienti esterni. Un cavo idoneo all'uso in ambienti esterni riduce il rischio di scosse elettriche.
- f. Quando l'utilizzo di un elettroutensile in ambiente umido è inevitabile, proteggere la presa di corrente e il relativo circuito elettrico con un dispositivo differenziale (RCD). L'uso di un dispositivo differenziale riduce notevolmente il rischio di scosse elettriche.

3. Sicurezza personale

- a. Lavorare sempre con la massima attenzione e concentrazione, lasciandosi guidare dal buon senso quando si usa un elettroutensile. Non usare mai un elettroutensile quando si è stanchi o sotto l'effetto di medicinali e/o sostanze alcoliche o stupefacenti. Quando si usa un elettroutensile un attimo di distrazione è sufficiente a causare gravi lesioni alle persone.
- b. Usare dispositivi per la protezione personale. Indossare sempre protezioni per gli occhi. I dispositivi per la sicurezza personale, come le mascherine antipolvere, le calzature di sicurezza antiscivolo, il casco e le cuffie, se usati in maniera appropriata, riducono i rischi di lesioni alle persone.
- c. Evitare l'avviamento accidentale della macchina. Accertarsi che l'interruttore sia spento prima di collegare la macchina alla presa di corrente. Quando si trasportano gli elettroutensili con il dito sull'interruttore di accensione o quando si collegano alla rete dispositivi che hanno l'interruttore in posizione ON (e cioè accesi) il rischio di causare incidenti è maggiore.
- d. Rimuovere tutte le chiavi di regolazione e le chiavi inglesi prima di accendere l'elettroutensile. Una chiave inglese o una chiave di regolazione collegata a una parte in movimento dell'elettroutensile potrebbe causare lesioni alle persone.
- e. Non sporgersi e tenere sempre una postura naturale. Mantenere sempre i piedi poggiati su superfici solide e non usare gli elettroutensili in equilibrio precario. Un buon equilibrio

consente di avere il massimo controllo sull'elettrotensile anche nelle situazioni inaspettate.

- f. Indossare indumenti adatti. Non indossare indumenti troppo larghi o gioielli. Tenere i capelli, gli indumenti e i guanti lontano dalle parti in movimento. Gli indumenti larghi, i gioielli e i capelli lunghi potrebbero rimanere impigliati tra le parti in movimento.
- g. Se il dispositivo utilizzato è dotato di bocchetta per l'aspirazione dei trucioli accertarsi che sia collegato e utilizzato correttamente. L'uso di tali dispositivi riduce i rischi correlati alle polveri.

4. Uso e cura dell'elettrotensile

- a. Non forzare l'elettrotensile. Usare sempre l'elettrotensile corretto per il lavoro da eseguire. L'elettrotensile corretto sarà in grado di svolgere il lavoro in modo più efficiente e sicuro perché è stato progettato appositamente per tale applicazione.
- b. Non usare l'elettrotensile se l'interruttore di accensione non si accende e si spegne. Gli elettrotensili con un interruttore di accensione difettoso sono pericolosi e devono essere riparati.
- c. Staccare sempre la spina dalla presa di corrente prima di effettuare regolazioni, collegare e scollegare accessori e prima di rimettere a posto l'elettrotensile. Questi accorgimenti riducono il rischio di un avvio accidentale dell'elettrotensile.
- d. Conservare l'elettrotensile fuori dalla portata dei bambini e non lasciare che venga utilizzato da persone non adeguatamente addestrate e competenti nell'uso degli elettrotensili o che non hanno preso visione di queste istruzioni. Gli elettrotensili diventano estremamente pericolosi nelle mani di persone non addestrate.
- e. Staccare sempre la corrente dall'elettrotensile quando l'area non è presidiata. Queste misure preventive di sicurezza riducono il rischio di un avvio accidentale dell'elettrotensile da parte di persone non addestrate.
- f. Mantenere gli elettrotensili in buone condizioni operative. Prima di utilizzare l'elettrotensile è necessario controllare che le parti in movimento siano allineate e che si possano muovere liberamente. Controllare inoltre che tutti i componenti siano privi di guasti e difetti che potrebbero ridurre la funzionalità del dispositivo. Non usare

un elettrotensile danneggiato e rivolgersi a un centro di assistenza autorizzato per la riparazione. Le cattive condizioni degli elettrotensili sono responsabili di un gran numero di incidenti.

- g. Mantenere le lame e pulite e affilate. Le lame mantenute affilate e in buone condizioni operative sono meno soggette a bloccarsi, e rendono più facile il controllo dell'utensile.
- h. Utilizzare l'elettrotensile e tutti i componenti e gli accessori in conformità con le istruzioni di questo manuale e nella maniera prevista per ciascun tipo di utensile, tenendo conto delle condizioni lavorative e del compito da eseguire. L'utilizzo degli elettrotensili per fini diversi da quelli previsti rappresenta un rischio per le persone.

5. Assistenza

- a. Qualsiasi intervento sull'elettrotensile deve essere eseguito da personale qualificato utilizzando unicamente pezzi di ricambio compatibili e approvati. Ciò garantisce la sicurezza dell'elettrotensile.

SIMBOLI

PROTEZIONE AMBIENTALE



Il simbolo del cestino barrato indica che il prodotto, una volta diventato inservibile, non deve essere gettato tra i rifiuti domestici ma conferito ad un centro di raccolta differenziata per apparecchi elettrici ed elettronici oppure riconsegnato al rivenditore al momento dell'acquisto di apparecchio sostitutivo.



Indossare sempre protezioni per gli occhi e per le vie respiratorie.



Con doppio isolamento



Avvertenza nelle istruzioni.



Non usi prima dell'osservazione e della comprensione le istruzioni di funzionamento complete



Fare riferimento al DVD per le istruzioni complete

MONTAGGIO DELLA SEGA ELETTRICA TRITON 235MM

Montaggio del telaio a slitta

Porre il telaio a slitta (L) nei canali cuscinetti con il gancio in plastica rosso e i distanziatori rossi dei cuscinetti nel pannello anteriore (dalla parte della scatola di commutazione) e le flange rivolte verso l'alto. Inserire due cuscinetti negli alloggiamenti del canale. Far scorrere il telaio verso il pannello posteriore e gli altri cuscinetti si inseriranno da soli.



Irrorare i canali con lubrificante tipo CRC o WD40 per uno scorrimento più facile.

Montaggio della sega triton

Scollare la sega. Controllare che la lama sia a 0° e impostata sulla massima profondità di taglio.

Montare le camme di allineamento sega (o) da sotto, tenendo le basi negli alloggiamenti rettangolari quando si avvitano. (Sono dispositivi autoflettanti.) Accertarsi che le linee stampate sulla parte



superiore delle camme puntino entrambe verso il pannello posteriore. Stringere le viti fino a quando si agganciano delicatamente.

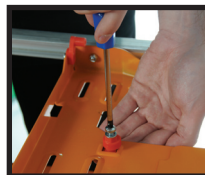

Montaggio dei localizzatori e delle manopole della sega

Montare la sega nel telaio posizionando le camme di allineamento nei fori della piastra base della sega.

Staccare i localizzatori della sega (k) e le manopole (l) dal relativo stampo e rimuovere l'eccesso di plastica nei punti di rottura con un coltellino affilato. Montare i quattro localizzatori della sega nei fori utilizzando le 4 viti Phillips (m) e i dadi-flangia (n). I bordi dritti dovranno essere quasi a contatto della piastra base, ma distanziati leggermente per consentire la regolazione finale della sega.

(Usare una spatula o un pezzo di cartone o di ferro da circa 1 millimetro di spessore come distanziatore.) Serrare saldamente le viti.



Avvitare le manopole (sono autofilettanti) fino a quando entrano a contatto con il bordo superiore della piastra base della sega. Tale contatto dovrà servire a stabilire una tensione sufficiente a mantenere la sega rovesciata in posizione per la regolazione finale e a consentire un leggero spostamento laterale della stessa utilizzando le camme di allineamento.

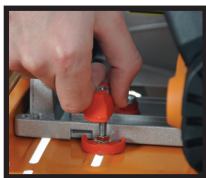

Controllare che la sega sia montata saldamente. Capovolgere il telaio a slitta, re-innestando i cuscinetti nei canali.



Allineamento della sega

Posizionare il telaio a metà strada tra i pannelli laterali. Regolare la guida vicino alla lama e fissarla in posizione. Accertarsi che la lama sia in posizione verticale confrontandola con la superficie della guida. Se necessario allentare i dadi che tengono il dispositivo di allineamento della lama e regolare l'angolazione della lama. Stringere il bullone.

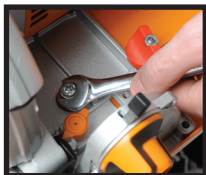

Usare la chiave della sega o delle chiavi a tubo per girare le camme fino a che le parti anteriore e posteriore della lama entrano leggermente a contatto con la guida posizionata a 0 mm.



Quando la posizione risulta soddisfacente, stringere saldamente le viti delle camme di allineamento.

Svitare l'impugnatura anteriore della sega per un accesso più facile alla camma anteriore. Abbassare la lama per accedere più facilmente a quella posteriore.

Fissaggio finale della sega

Ricontrollare la corretta posizione della sega bloccando la guida su 0mm. Controllare manualmente che la lama giri all'indietro.

I denti dovrebbero "graffiare" leggermente la superficie della guida. In caso contrario, ripetere la procedura di allineamento di cui sopra.



Questa fase è estremamente importante perché consente di produrre tagli accurati con la propria sega, e di ottenere scale della guida precise. Pertanto si consiglia di fare il lavoro senza fretta e con attenzione.

Quando la posizione della sega sarà soddisfacente, riposizionare i localizzatori della sega sulla piastra base come segue.

Tenere ciascuna maniglia per evitare che giri e allentare la vite da un giro a mezzo giro. Spingere in posizione il localizzatore della sega e stringere bene la vite.



Capovolgere la sega e allentare le quattro manopole di un paio di giri. Controllare che la sega non si possa spostare lateralmente e che tutte le viti siano strette a fondo. Stringere di nuovo le manopole, ma questa volta dando un giro in più rispetto a quando dovevano sfiorare leggermente la piastra base.

A questo punto la sega è installata e potrà essere scollegata in qualsiasi momento per essere utilizzata autonomamente, semplicemente allentando ciascuna delle manopole di mezzo giro per sollevare ed estrarre la sega. Se i localizzatori sono montati correttamente la sega si riposiziona ogni volta con precisione al posto giusto.



Montaggio della protezione laterale

Infilare le due sezioni della protezione laterale (K) l'una nell'altra fino a quando si montano sulle staffe orientabili del telaio a slitta. Puntare la vite Philips più corta (i) a un dado Nyloc (h) per tenere insieme il tutto.

Montare le due viti Philips più lunghe (j) e i dadi Nyloc attraverso le staffe orientabili e nelle flange della protezione. Stringere fino a quando la protezione è fissata saldamente ma può ancora essere orientata. Infine, stringere la vite che tiene insieme le due parti.



Montaggio della cinghietta di innesto della sega

! Prima di montare la cinghietta di innesto (q) accertarsi sempre che la sega sia scollegata dall'alimentazione e che l'interruttore nel pannello frontale del banco da lavoro Workcentre sia in posizione "OFF" (spento).

Infilare la cinghietta di innesto (q) sull'impugnatura con la parte con la lanetta rivolta verso l'esterno. Passare la cinghietta attraverso la fibbia accertandosi che passi anche l'anello di sicurezza. Se la sega ha un pulsante di sicurezza lock-out premerlo e stringere la cinghietta finché il pulsante si accende ("ON").

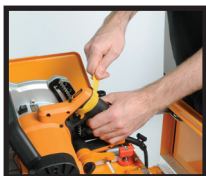

Avvolgere la parte terminale della cinghietta attorno all'impugnatura.

Con la maggior parte delle seghe sul mercato, la cinghietta potrà essere infilata e sfilata dal pulsante della sega senza doverla stringere ogni volta.

Non lasciare la cinghietta di innesto permanentemente collegata. Al termine della giornata lavorativa allentare la cinghietta e lasciare che la molla del pulsante dell'interruttore si rilasci.



Montaggio del banco

Capovolgere il telaio a slitta. Posizionarlo approssimativamente a metà strada tra i pannelli laterali. La parte anteriore della sega dovrà essere rivolta verso il pannello anteriore (dalla parte della scatola di commutazione).

Abbassare il Piano di lavoro (A) sulla lama, con i quattro alloggiamenti a T più vicino al pannello posteriore. Allineare le frecce sui bordi del piano di lavoro con i puntatori della scala nella parte superiore dei pannelli finali. Spingere i fermi del piano di lavoro in posizione di blocco (LOCK). Gli indicatori rossi spariranno quando i fermi saranno posizionati correttamente.



UNLOCKED



LOCKED

Mettere la mano sotto e premere il telaio a slitta verso il pannello posteriore fino a quando il fermo rosso si aggancia con un clic in posizione e blocca il telaio sotto il piano di lavoro.



Montaggio della protezione superiore e del supporto

Allentare la manopola della protezione superiore (J) per rimuovere il supporto protezione dalla sua posizione di trasporto. Montare il supporto nel foro centrale del piano di lavoro, utilizzando i fori all'estremità. Accertarsi che la lama sia regolata alla massima profondità e quindi posizionare il supporto a circa 12mm dietro la lama e bloccarla premendo la leva di blocco verso il basso.



Lubrificare l'ingresso se lo spazio è troppo stretto o il montaggio è difficoltoso.

Controllare che il supporto protezione sia sufficientemente a squadra rispetto al banco, e regolarlo se necessario spingendo in modo uniforme con la mano o con un pezzo di legno.



Tenere 2 pezzi di legno dritto leggermente a contatto della lama. Il supporto della protezione superiore dovrebbe entrare tra questi due pezzi di legno.



In caso contrario sarà necessario regolare leggermente la posizione della sega. Ciò sarà necessario se il solco di taglio della lama è particolarmente stretto (larghezza di taglio 2,0 - 2,2mm)

Montare e abbassare la protezione. Far girare la lama con la mano prima di collegare l'alimentazione per accertarsi che non entri a contatto con altre parti.



 Controllare sempre che la lama sia alla massima altezza, che la protezione sia montata, e che il piano di lavoro sia fissato ai pannelli alle estremità prima di mettere in tensione la macchina. Controllare che i denti della lama siano puntati nella

stessa direzione dei simboli incisi sulla protezione. In caso contrario la lama sarà stata montata in modo errato nella sega.

Collegamento dell'alimentazione

Accertarsi che l'interruttore sia spento (OFF). Collegare la spina della sega alla scatola di commutazione, e collegare la scatola di commutazione alla presa di corrente utilizzando una prolunga di amperaggio adeguato.

Premere il pulsante bianco con il dito per accendere (ON) l'alimentazione. Premere il pulsante di arresto con la mano o con il ginocchio per spegnere (OFF).



Accendere e spegnere l'alimentazione e osservare la lama. Se vibra da una parte all'altra all'avvio probabilmente l'alberino della sega è usurato, o i montanti tra il motore e la piastra base sono eccessivamente allentati.

Se la lama vibra significativamente ad alta velocità o durante la fase di rallentamento, probabilmente è piegata o non correttamente allineata sull'alberino. Usare una squadra per controllare che la lama sia piatta, controllare inoltre che le rondelle o eventuali riduttori siano montati correttamente e che non vi siano depositi di resina/segatura sull'alberino, sulle rondelle e sulla flangia.

Una leggera vibrazione normalmente si avverte sulla maggior parte delle lame al momento del rallentamento, e non dovrebbe influire sul rendimento durante il taglio.

GARANZIA

Per la registrazione della garanzia visitare il sito web www.tritontools.com* e inserire i propri dettagli.

A meno che il proprietario non abbia specificato diversamente, i suoi dettagli saranno inclusi nella lista di distribuzione che sarà utilizzata per inviare regolarmente informazioni sulle novità Triton. I dati personali raccolti saranno trattati con la massima riservatezza e non saranno rilasciati a terze parti.

INFORMAZIONI SULL'ACQUISTO

Data di acquisto: ___ / ___ / ____

Modello N.: WCA201

Numero di serie: _____

(dati sull'etichetta del motore)

Conservare lo scontrino come prova dell'acquisto

Triton Precision Power Tools garantisce al proprietario di questo prodotto che se dovessero essere riscontrati difetti di materiali o lavorazione entro 12 MESI dalla data dell'acquisto originale, effettuerà gratuitamente la riparazione o, a propria discrezione, la sostituzione dei componenti difettosi.

Questa garanzia non è applicabile per l'uso commerciale dell'utensile ed esclude la normale usura o i danni causati all'utensile da incidenti, uso improprio, abusi o alterazioni.

* Registrati on-line entro 30 giorni.

Condizioni di applicazione.

Questa garanzia non pregiudica in alcun modo i diritti del consumatore stabiliti dalla legge.

Este producto tiene un número de características únicas. Incluso si está familiarizado con este Workcentre, por favor lea este manual para asegurarse de obtener el beneficio completo de su diseño único.

Mantenga este manual a mano y asegúrese de que todos los usuarios de esta herramienta han leído y entendido las instrucciones.

ÍNDICE

Especificaciones	45
Lista de piezas	46
Seguridad	47
Símbolos	48
Montaje de la sierra Triton	49
Garantía	53
Declaración "CE" de conformidad	54

ESPECIFICACIONES

Pieza n°:	WCA201
Para:	La mayoría de las sierras circulares (185mm - 235mm)
Cortes:	Rasgado, inglete, rasgado a bisel de 45°, corte transversal, corte transversal a bisel, inglete compuesto
Capacidad de rasgado:	0 - 620mm
Capacidad de corte transversal:	Ancho de hasta 500mm
Tamaño de pie:	900mm x 600mm x 1300mm aprox.
Tamaño plegado:	350mm x 440mm x 1000mm aprox.
Características estándar:	Transportador de 3 lados (ajusta 45° hasta 0° hasta 45°), cerca de rasgado con cara de bisel de 45°, patas plegables, caja de interruptores con apagado de seguridad, protector de cuchilla con puerta de polvo y protección de retroceso, abrazaderas de sierra de desenganche rápido, protector del lado de la sierra, cerca de corte transversal, impulsor de seguridad y dedo de presión lateral.
Accesorios opcionales:	Mesa de extensión deslizante, mesa de buriladora, kit de sierra de vaivén, ensamblador de bizcochos, empalmador de dedos, kit de sujeción de aplanador, colector de polvo, guía de rasgado de bisel, embobinador de altura, ruedas retraíbles.

Protéjase los oídos

Use siempre protección acústica adecuada cuando el ruido de la herramienta supere los 85dB.

LISTA DE PIEZAS

A. Mesa (1)

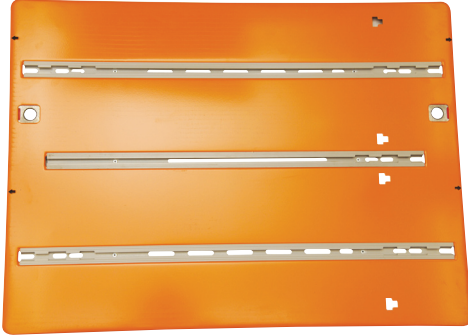

H. Cerca de corte transversal (1)



B. Panel delantero (1)



C. Panel delantero (1)



L. Chasis deslizante (1)

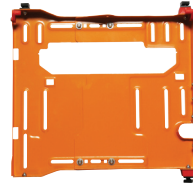

J. Protector superior y soporte del protector (1)



M. Empujador guiado y kit de dedo de presión lateral

F. Canales de base (2)



G. Transportador (1)



K. Protector lateral (2)



E. Canales de rodamientos (2)



N. Guías de bisel de la cerca de rasgado (2)



I. Cerca de rasgado (1)



D. Patas (4)



BOLSA PRINCIPAL DE CIERRE



a. Pasador de bloqueo de la pata (4)



b. 16 pernos M8 (4)



c. Tuerca con pestaña M8 (4)



d. Rondella 8mm (20)



e. Tuerca nyloc M8 (8)



f. 50 pernos M8 (8)



g. Soporte colgante de empujador (2)



h. Tuerca nyloc M5 (3)



i. 8 tornillos M5 (2)



j. 25 tornillos M5 (1)

k. Localizadores de sierra (4)

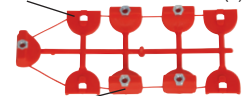

l. Perillas de abrazadera (4)



m. 40 tornillos M6 (4)



n. Tuerca con pestaña M6 (4)



p. Pie inclinado (4)



q. Correa del disparador (1)



r. Soporte colgante de la cerca (2)



s. Llave de tubo (1)



u. Etiquetas indicadoras de escala (1)



INSTRUCCIONES DE SEGURIDAD



AVISO. Lea todas las advertencias de seguridad y todas las instrucciones.

El incumplimiento de los avisos y las instrucciones puede ser causa de electrochoque, incendio o lesiones graves.

Guarde todos los avisos e instrucciones para su referencia futura.

El término “herramienta eléctrica” utilizado en los avisos se refiere a las herramientas enchufables a la red eléctrica (con cable) o a baterías (sin cable).

1. Seguridad del área de trabajo

- Mantenga el lugar de trabajo limpio y bien iluminado. Los sitios desordenados y oscuros producen accidentes.
- No utilice herramientas eléctricas cuando el aire pueda ser explosivo, como por ejemplo en la proximidad de líquidos, gases o polvo inflamables. Las herramientas eléctricas producen chispas que pueden inflamar el polvo o los gases.
- Mantenga alejados a los niños y los curiosos cuando utilice una herramienta eléctrica. Las distracciones pueden hacer que pierda el control.

2. Aspectos de seguridad sobre la electricidad

- Las clavijas de las herramientas eléctricas deben ser del mismo tipo que el enchufe. No modifique nunca la clavija de ninguna manera. No use adaptadores de clavijas con las herramientas eléctricas con masa (toma de tierra). Las clavijas sin modificar y los enchufes del mismo tipo reducen el riesgo de electrochoque.
- Evite que el cuerpo entre en contacto con las superficies con toma de tierra como por ejemplo tuberías, radiadores, cables de prolongación y refrigeradores. Hay mayor riesgo de electrochoque si el cuerpo tiene toma de tierra o contacto de masa.
- No exponga las herramientas eléctricas a la lluvia ni a condiciones húmedas. Si el agua se introduce en la herramienta eléctrica aumentará el riesgo de electrochoque.
- No use incorrectamente el cable. No lo use nunca para transportar la herramienta eléctrica, tirar de ella o desenchufarla.
Mantenga el cable alejado del calor, aceite, objetos afilados o piezas móviles. Los cables dañados o enredados aumentan el riesgo de

electrochoque.

- Al utilizar la herramienta eléctrica en el exterior, use un cable de prolongación adecuado para este uso. El uso de un cable de prolongación adecuado para el exterior reduce el riesgo de electrochoque.
- En caso de tener que usar la herramienta eléctrica en un sitio húmedo, utilice una fuente de alimentación protegida por un dispositivo de corriente residual. El uso de este tipo de dispositivo reduce el riesgo de electrochoque.

3. Aspectos de seguridad personal

- Manténgase alerta, preste atención a lo que hace y use el sentido común al utilizar la herramienta eléctrica.
No use la herramienta eléctrica cuando esté cansado o bajo los efectos de las drogas, el alcohol o las medicinas. Un momento de distracción al usar la herramienta eléctrica puede causarle lesiones graves.
- Utilice equipo de seguridad. Póngase siempre protección en los ojos. El uso de equipo de seguridad como por ejemplo mascarilla, calzado antideslizante, casco y protección acústica cuando es necesario reduce las lesiones personales.
- Evite el encendido accidental. Asegúrese de que el interruptor esté en la posición de apagado antes de enchufarlo. El transporte de herramientas eléctricas con el dedo puesto en el interruptor o enchufarlas cuando este interruptor está encendido puede provocar accidentes.
- Quite las llaves de tuercas antes de encender la herramienta eléctrica. Si deja una llave acoplada a una parte giratoria de la herramienta eléctrica puede provocar lesiones personales.
- No intente alcanzar más allá de lo que sea seguro. Mantenga los pies firmes en el suelo y el equilibrio en todo momento. De esta manera tendrá un mejor control de la herramienta eléctrica en situaciones inesperadas.
- Póngase prendas adecuadas. No se ponga ropa floja ni joyería. No deje que el pelo, la ropa o los guantes entren en contacto con las piezas móviles. La ropa, joyería o el pelo largo se pueden enganchar en las piezas en movimiento.
- Si se suministran dispositivos para conectar extractores y colectores de polvo, asegúrese

de que estén conectados y de que se usen correctamente. El uso de estos dispositivos puede reducir los peligros relacionados con el polvo.

4. Uso y cuidado de la herramienta eléctrica

- No fuerce la herramienta eléctrica. Use la herramienta eléctrica apropiada para el trabajo a realizar. La herramienta eléctrica correcta hará el trabajo mejor y con más seguridad a la velocidad para la que fue diseñada.
- No use la herramienta eléctrica si el interruptor no funciona. Cualquier herramienta eléctrica que no pueda apagarse o encenderse con el interruptor es peligrosa y debe ser reparada.
- Desconecte la clavija de la fuente de alimentación antes de hacer cualquier ajuste, cambiar accesorios o guardar la herramienta eléctrica. Con estas medidas preventivas de seguridad se reduce el riesgo de que la herramienta eléctrica se ponga en marcha accidentalmente.
- Guarde las herramientas eléctricas que no utilice fuera del alcance de los niños y no deje que las usen personas no familiarizadas con ellas o con estas instrucciones. Las herramientas eléctricas son peligrosas en las manos de personas sin entrenamiento para ello.
- Desenchufe siempre la herramienta eléctrica cuando la deje sin supervisión. Con estas

medidas preventivas de seguridad se reduce el riesgo de que personas sin entrenamiento pongan en marcha la herramienta eléctrica.

- Realice el mantenimiento de las herramientas eléctricas. Compruebe si hay mala alineación o agarrotamiento de las piezas móviles, rotura de piezas o cualquier otro problema que pueda afectar al funcionamiento de las herramientas eléctricas. Si se daña, haga que la reparen antes de volver a usarla. Muchos accidentes son consecuencia de un mantenimiento defectuoso.
- Mantenga las herramientas de corte afiladas y limpias. Las herramientas de corte bien mantenidas y con los bordes de corte afilados tienen menor probabilidad de agarrotarse y son más fáciles de controlar.
- Use la herramienta eléctrica, los accesorios y las brocas, etc... siguiendo estas instrucciones y de la manera prevista para ese tipo de herramienta eléctrica, teniendo en cuenta las condiciones de trabajo y el trabajo a realizar. El uso de la herramienta eléctrica para fines distintos a los previstos podría ser causa de situaciones peligrosas.

5. Servicio

- Haga que el servicio de la herramienta eléctrica lo realice una persona cualificada, empleando sólo recambios idénticos a los originales. Con ello se asegurará de mantener la seguridad de la herramienta eléctrica.

SÍMBOLOS

PROTECCIÓN MEDIOAMBIENTAL



Los desechos procedentes de los productos eléctricos no deben eliminarse con la basura casera. Recíclelos en las instalaciones pertinentes si existen. Consulte con las autoridades locales o con su minorista para consejo sobre el reciclado.



Lleve siempre protección auditiva, ocular y respiratoria.



Doble aislamiento.



Advertencia sobre instrucciones.



No utilice antes de la visión y de la comprensión las instrucciones de manejo completas



Remítase al DVD para ver las instrucciones completas

MONTAJE DE LA SIERRA ELÉCTRICA TRITON 235MM

Montaje del chasis deslizante

Ponga el Chasis Deslizante (L) en los canales de apoyo con el fiador de plástico rojo y los espaciadores rojos de apoyo más cercanos al panel delantero (el extremo de caja de interruptores) y los rebordes hacia arriba. Ponga dos puntos de apoyo en los huecos del canal. Deslice el chasis hacia el panel posterior y los otros apoyos caerán en su sitio.

Ponga RP7 o WD40 en los canales para un deslizamiento suave.



Montaje de la sierra triton

Desenchufe la sierra. Compruebe que la cuchilla esté a 0° y a máxima profundidad de corte.

Ponga las levas de alineación de la sierra (o) desde abajo, sujetando las bases en las ranuras rectangulares mientras las atornilla (hacen su propia rosca). Asegúrese de que las dos líneas moldeadas en la parte superior de las levas apunten hacia el panel posterior. Apriete los tornillos hasta que se hundan ligeramente.

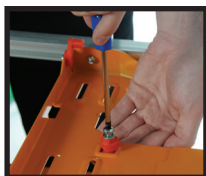

Montaje de los localizadores y perillas de la sierra

Monte la sierra en el chasis con las levas de alineación en los agujeros de la placa base. Rompa o corte los localizadores (k) y perillas (l) de la sierra del "árbol" de moldura, recortando con cuidado las rebabas con un cuchillo afilado. Ponga los localizadores de la sierra en las ranuras que se indican con 4 tornillos Philips (m) y tuercas tapón (n). Los bordes rectos deben quedar contra la placa base, pero espaciados ligeramente con el fin de permitir el ajuste final de la sierra.

(Use una espátula o un trozo de cartón o metal de aproximadamente 1mm de grosor como espaciador). Apriete firmemente los tornillos.

Enrosque las perillas (hacen su propia rosca) hasta que apenas rocen el borde superior de la placa base. Esta tensión es suficiente para sujetar la sierra boca abajo para su ajuste final, y dejar que se desplace lateralmente un poco mediante las levas de alineamiento.

Compruebe que la sierra esté firmemente montada. Dé la vuelta al chasis deslizante, volviendo a poner los apoyos en los canales.



Alineación de la sierra

Ponga el chasis a mitad de camino entre los paneles terminales. Ajuste la cerca hasta que quede próxima a la cuchilla, y bloquéela. Asegúrese de que la cuchilla esté vertical

comparándola con la superficie de la cerca. Si fuera necesario, afloje la tuerca que sujeta el Ajustador del Ángulo de la Cuchilla, y ajuste el ángulo. Vuelva a apretar la tuerca.

Use la llave de la sierra o la llave de tubos (s) para girar las levas hasta que tanto la parte delantera como la trasera de la cuchilla queden apenas tocando la cerca, cuando está a 0mm. Al llegar a la posición deseada, apriete los tornillos de levas de alineación.

Destornille la manija delantera de la sierra para conseguir un mejor acceso a la leva delantera. Baje la cuchilla para acceder a la leva posterior.



Fijación final de la sierra

Compruebe otra vez la posición de la sierra bloqueando la cerca a 0mm e intentando hacer girar la cuchilla hacia atrás con la mano. Los dientes deberán rozar ligeramente la superficie de la cerca. Si no la rozan, repita nuevamente la



alineación indicada más arriba.

Este es un paso muy importante porque garantiza que los cortes de la sierra sea exactos, y que las escalas de la cerca sean precisas: tómese todo el tiempo que necesite.

Cuando la posición de la sierra sea la que desee, vuelva a situar los localizadores totalmente contra el borde de la placa base, de la siguiente manera: sujete cada perilla para que no gire y afloje el tornillo media vuelta o una vuelta entera. Ponga el localizador en su sitio mediante presión, y apriete firmemente el tornillo.

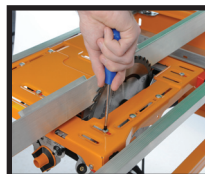

Vuelva a poner la sierra boca arriba y afloje las cuatro perillas un par de vueltas. Compruebe que la sierra no se pueda mover nada lateralmente, y que todos los tornillos estén bien apretados. Vuelva a poner las perillas, aproximadamente una vuelta a partir del punto en que empiezan a rozar la placa base.

Ya está montada la sierra, y está disponible para su uso manual en cualquier momento con sólo aflojar cada perilla media vuelta y subir la sierra hacia arriba. Si los localizadores están montados correctamente, la sierra siempre volverá exactamente al punto previsto.



Montaje del protector lateral

Deslice las dos partes del protector lateral (K) juntas hasta que encajen entre los soportes de pivote en el chasis deslizante. Ponga sin apretarlo el tornillo corto Philips (i) y una tuerca Nyloc (h) para sujetarlos juntos.

Ponga los dos tornillos más largos Philips (j) y las tuercas Nyloc en los soportes de pivote y en los rebordes del protector. Apriéte los hasta que el protector



quede firme, pero con giro libre. Finalmente, apriete el tornillo que sujeta juntas las dos mitades.

Montaje de la correa del disparador

! Antes de montar la correa del disparador (q) asegúrese siempre de que la sierra no esté enchufada a la corriente y que el interruptor que hay en el panel delantero del Centro de Trabajo esté en la posición "OFF" (apagado).

Enrolle la correa del disparador (q) alrededor de la manija con el lado afelpado hacia afuera. Pase la correa a través de la hebilla, hasta que el bucle de seguridad haya pasado del todo. Si la sierra tiene un botón de bloqueo de seguridad, púlselo y apriete la correa hasta que el disparador se ponga en la posición "ON".



Enrolle el extremo libre de la correa alrededor de la manija.

En la mayoría de las sierras, la correa se puede poner y quitar del disparador de la sierra sin tener que deshacerla cada vez.

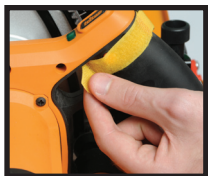

No deje la correa del disparador permanentemente bloqueada. Cuando haya acabado la jornada de trabajo, suelte la correa y deje que se relaje el muelle del disparador.

Montaje de la mesa

Ponga el chasis deslizante boca abajo. Colóquelo aproximadamente a medio camino entre los paneles extremos. La parte delantera de la sierra debe quedar hacia el panel delantero (extremo de la caja de interruptores).

Haga descender la mesa (A) sobre la cuchilla, con las cuatro ranuras en T más próximas al panel posterior. Alinee las



flechas que hay en los bordes de la mesa con los punteros de escala que hay en la parte superior de los paneles extremos. Presione los sujetadores de la mesa para ponerlos en la posición "LOCK" (bloqueados). Los indicadores rojos desaparecen cuando los sujetadores se enganchan a fondo.



UNLOCKED

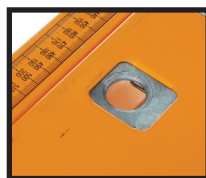

LOCKED

Con la mano por debajo, presione el chasis deslizante hacia el panel posterior hasta que el retén rojo haga clic y bloquee el chasis debajo de la mesa.



Montaje del protector y del soporte superior

Afloje el protector superior (J) para quitar el soporte del protector de su posición de transporte. Ponga el soporte en la ranura central de la mesa usando los cortes que hay en el extremo. Asegúrese de que la cuchilla de la sierra esté ajustada a su profundidad máxima, y a continuación sitúe el soporte unos 12mm detrás de la cuchilla y bloquéelo en su sitio haciendo presión hacia abajo en la palanca de bloqueo.

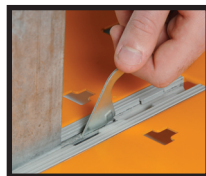

Lubrique el punto de entrada si está muy ajustado. Compruebe que el soporte del protector forme un ángulo bastante recto con respecto de la mesa, ajustándolo si fuera necesario empujándolo uniformemente con la mano o con un bloque de madera.



Coloque 2 trozos rectos de madera contra la cuchilla, sin hacer presión. El soporte del protector superior deberá encajar entre los trozos.



Si no encaja, puede que tenga que ajustar ligeramente la posición de la sierra. Esto sólo ocurrirá si el corte de la cuchilla es muy fino (ancho de corte 2.0 - 2.2mm).

Monte y haga descender el protector. Haga girar la cuchilla con la mano antes dar la corriente para asegurarse de que no entre en contacto con nada.



sierra estará desgastado, o habrá un juego excesivo en los soportes entre el motor y la placa base.

Si la cuchilla vibra notablemente a plena velocidad o al reducir la velocidad, será porque está deformada o no asentada correctamente en el eje. Compruebe: la planeidad de la cuchilla con un borde recto, el ajuste de las arandelas reductoras del eje que haya montadas, y si hay acumulación de resina/serrín en el eje o en las arandelas de pestañas.

Normalmente se puede notar una ligera vibración al reducir la velocidad en la mayoría de las cuchillas, pero ello no afecta al corte.

 Asegúrese siempre de que la cuchilla esté a su altura máxima, con el protector montado, y que la mesa esté bloqueada en los paneles extremos antes dar la corriente. Compruebe que los dientes de la cuchilla apunten en la misma dirección que los símbolos que hay grabados en el protector. De lo contrario, habrá montado la cuchilla incorrectamente en la sierra.

Encendido de la sierra

Asegúrese de que el interruptor esté en la posición "OFF" (apagado), enchufe la sierra en la caja de interruptores y conecte la corriente a través de un cable alargador del grosor adecuado.

Pulse el interruptor blanco con el dedo para ponerlo en la posición "ON" (encendido). Dé un golpecito en la placa de parada con la mano o rodilla para ponerlo en la posición "OFF".



Encienda la corriente y fíjese en la cuchilla. Si vibra lateralmente al arrancar, el eje de la

GARANTÍA

Para registrar su garantía visite nuestro sitio web en www.tritontools.com* e introduzca sus datos.

Estos datos serán incluidos en nuestra lista de correo (salvo indicación contraria) para recibir información sobre futuras ediciones. Los datos aportados no estarán a disposición de ningún tercero.

REGISTRO DE COMPRA

Fecha de compra: ____ / ____ / ____

Modelo: WCA201

Número de serie: _____

(situado en la etiqueta del motor)

Conserve su recibo como prueba de compra

Triton Precision Power Tools garantiza al comprador de este producto que si alguna pieza resulta ser defectuosa a causa de materiales o de mano de obra defectuosos dentro de los 12 MESES a partir de la fecha de la compra original, Triton reparará, o a su discreción, sustituirá la pieza defectuosa sin cargo.

Esta garantía no se aplica al uso comercial ni se amplía al desgaste normal o a los daños resultantes de un accidente, de un abuso o de una mala utilización.

* Regístrese online dentro de 30 días.

Sujeta a términos y condiciones.

Esto no afecta sus derechos legales.



DECLARATION OF CONFORMITY

The Undersigned: Mr Philip Ellis as authorized by: TRITON Declare that:

PRODUCT CODE: 330185 DESCRIPTION: Workcentre Series 2000

CONFORMS TO THE FOLLOWING DIRECTIVES: • DIN 02851-5 (VDE 0281 TELLS):2002-09;HD21.5S3:1994+A1:1999+A2:2001
• EN61058-1:1992+A1

THE TECHNICAL DOCUMENTATION IS KEPT BY TRITON

NOTIFIED BODY: VDE

PLACE OF DECLARATION: Offenbach, Germany

EG-VERKLARING VAN OVEREENSTEMMING

De Ondergetekende: Mr Philip Ellis Gemachtigd door: TRITON Declare that:

TYPE/ SERIENR: 330185 NAAM/MODEL: Reeks 2000 Workcentre

VOLDOET AAN DE VEREISTEN VAN DE RICHTLIJN: • DIN 02851-5 (VDE 0281 TELLS):2002-09;HD21.5S3:1994+A1:1999+A2:2001
• EN61058-1:1992+A1

DE TECHNISCHE DOCUMENTATIE WORDT BEWAARD DOOR TRITON

KEURINGSINSTANTIE: VDE

PLAATS VAN AFGIFTE: Offenbach, Germany

DÉCLARATION DE CONFORMITÉ CE

Le soussigné: Mr Philip Ellis autorisé par: TRITON Declare that:

TYPE/SERIE NO: 330185 NOM/MODEL: Série Workcentre 2000

SE CONFORME AUX DIRECTIVES SUIVANTES: • DIN 02851-5 (VDE 0281 TELLS):2002-09;HD21.5S3:1994+A1:1999+A2:2001
• EN61058-1:1992+A1

LA DOCUMENTATION TECHNIQUE EST ENREGISTRÉE PAR TRITON

ORGANISMES NOTIFIÉS: VDE

ENDROIT DE LA DÉCLARATION: Offenbach, Germany

KONFORMITÄTSEKLRÄRUNG

Name des Unterzeichners: Mr Philip Ellis Bevollmächtiger: TRITON Declare that:

BAUART./ SERIENNUMMER: 330185 NAME/ DER GERÄTETYP: Reihe Workcentre 2000

PASST SICH AN DIE FOLGENDEN RICHTLINIEN AN: • DIN 02851-5 (VDE 0281 TELLS):2002-09;HD21.5S3:1994+A1:1999+A2:2001
• EN61058-1:1992+A1

TECHN. UNTERLAGEN HINTERLEGT BEI TRITON

BENNANTE STELLE: VDE

ORT: Offenbach, Germany

EC DECHIARAZIONE DI CONFIRMITÀ

Il sottoscritto: Mr Philip Ellis Come autorizzato di: TRITON Declare that:

TIPO/ NUMERO DI SERIE: 300185 NOME/ MODELLO: Serie Workcentre 2000

SI CONFORMA ALL' INDIRIZZAMENTO: • DIN 02851-5 (VDE 0281 TELLS):2002-09;HD21.5S3:1994+A1:1999+A2:2001
• EN61058-1:1992+A1

IL DOCUMENTAZIONE TECNICO É MANTENUTO DI TRITON

CORPO INFORMATO: VDE

POSTO DI DICHIARAZIONE: Offenbach, Germany

DECLARACIÓN "CE" DE CONFORMIDAD

El abajo firmante: Mr Philip Ellis Autorizad por: TRITON Declare that:

TIPO Y NO SERIE: 330185 MODELO/NOMBRE: Serie Workcentre 2000

SE HALLA EN CONFORMIDAD CON LA DIRECTIVA: • DIN 02851-5 (VDE 0281 TELLS):2002-09;HD21.5S3:1994+A1:1999+A2:2001
• EN61058-1:1992+A1

LA DOCUMENTACIÓN TÉCNICA SE GUARDA POR TRITON

ORGANISMO NOTIFICADO: VDE

LUGAR DE DECLARACIÓN: Offenbach, Germany

Date: 21/06/10

Signed by:

Mr Philip Ellis
Managing Director

Assembly & Operating Manual



TABLESAW MODE



CROSSCUT MODE

A WORD FROM THE MANUFACTURERS

Thank you for your purchase of the Triton Series 2000 Workcentre. If properly set up, and fitted with a good quality saw and blade, it will give you great accuracy and many years of trouble-free service.

To set up properly, make sure you follow this manual. Otherwise you could spend many unnecessary hours, and still not get it right.

TERMS AND SYMBOLS USED IN THIS MANUAL

“Front of the Workcentre” refers to the end which has the switchbox. The “left-hand & right-hand side” are when viewed from the front of the Workcentre.

Safety warning or safety instruction.

Possible fitting or operating difficulty.

Handy hint & tip.

⚠ Take special note of this instruction.

⊘ WARNING! Do not attempt this.

Parts list	2	Test Cuts - Table saw mode	12-13
Basic assembly diagram	3	Test Cuts - Crosscut mode	13-14
Fitting the Triton Precision Saw	4-5	Operating - Table saw	15-23
Fitting other brands of saw	6-7	Operating - Crosscut saw	24-27
Final assembly	8-11	Warranty & Mailing List	28

PARTS LIST

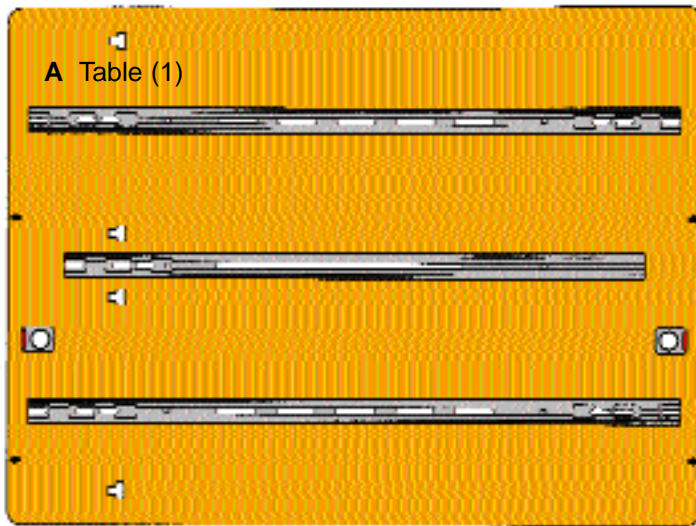

A Table (1)



H Crosscut Fence (1)

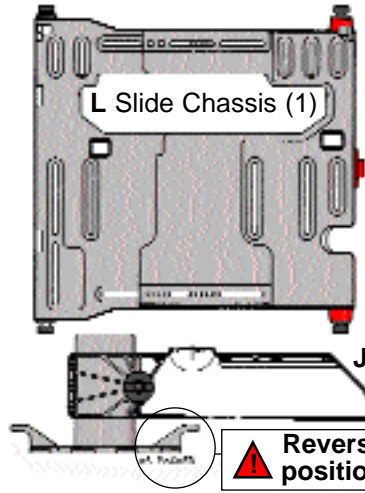

L Slide Chassis (1)

J Overhead Guard & Guard Support (1)

Reverse from packed position before using



B Front End Panel (1)



C Rear End Panel (1)

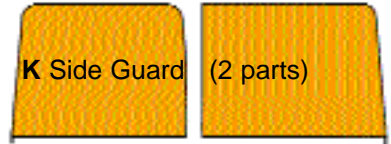

K Side Guard (2 parts)

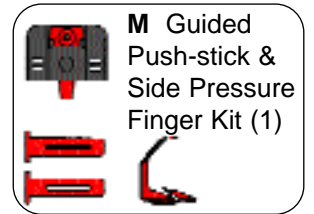

M Guided Push-stick & Side Pressure Finger Kit (1)



F Base Channels (2)



E Bearing Channels (2)



I Rip Fence (1)

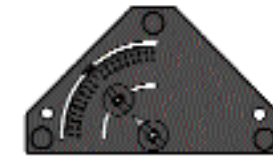

G Protractor (Mitre gauge) (1)



N Rip Fence Bevel Guides (2 parts)

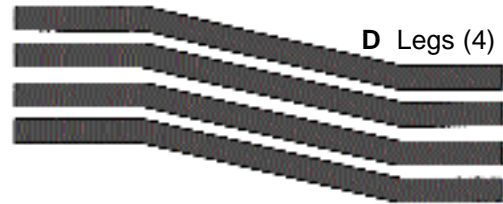

D Legs (4)

MAIN FASTENER BAG

a. Leg Locking Pin (4)

b. M8 x 16 Bolt (4)

c. M8 Flange Nut (4)

d. 8mm Washer (20)

e. M8 Nyloc Nut (8)

f. M8 x 50 Bolt (8)

g. Push-stick hanger (2)

SAW CLAMPING HARDWARE (SEPARATE BAG)

h. M5 Nyloc Nut (3)

i. M5 x 8 Screw (2)

j. M5 x 25 Screw (1)

k. Saw Locators (4)

l. Clamping Knobs (4)

m. M6 x 40mm Philips-head Screws (4)

n. M6 Flange Nuts (4)

o. Alignment Cams for Triton Saw (2 sets packed in separate bag)

p. Angled foot (4)

q. Trigger Strap

r. Fence Hanger (2)

s. Tube Spanner

t. Router Table Fitting Kit

u. Scale Pointer Labels (1)

- STEP 1:** Fit the Legs (D) to each End Panel (B & C). Before fitting, check that each leg splays outwards as shown, and that you have fitted the Leg Locking Pin (a) with the spring-loaded ball facing outwards. Tighten the bolts so that the legs are firm, but still free to pivot. Use four M8 x 50 bolts (f), eight washers (d) and four M8 Nyloc nuts (e).
- STEP 2:** Fit the Base Channels (F) as shown. Tighten the bolts until the leg brackets close firmly on the base channels. **Do not overtighten.** The Nyloc nuts used are vibration proof and won't come undone. Use four M8 x 50 bolts, eight washers and four Nyloc nuts.
- STEP 3:** Fit the Flange Nuts (c) inside the Bearing Channels (E) and fit the bearing channels to the end panels. They should click into position when pushed up from below. Fully tighten the bolts. Use four M8 x 16 bolts (b), four 8mm washers (d) and four flange nuts.
- STEP 4:** Fit the plastic components (r, g & p) as shown, and then fit the Rip Fence (I).

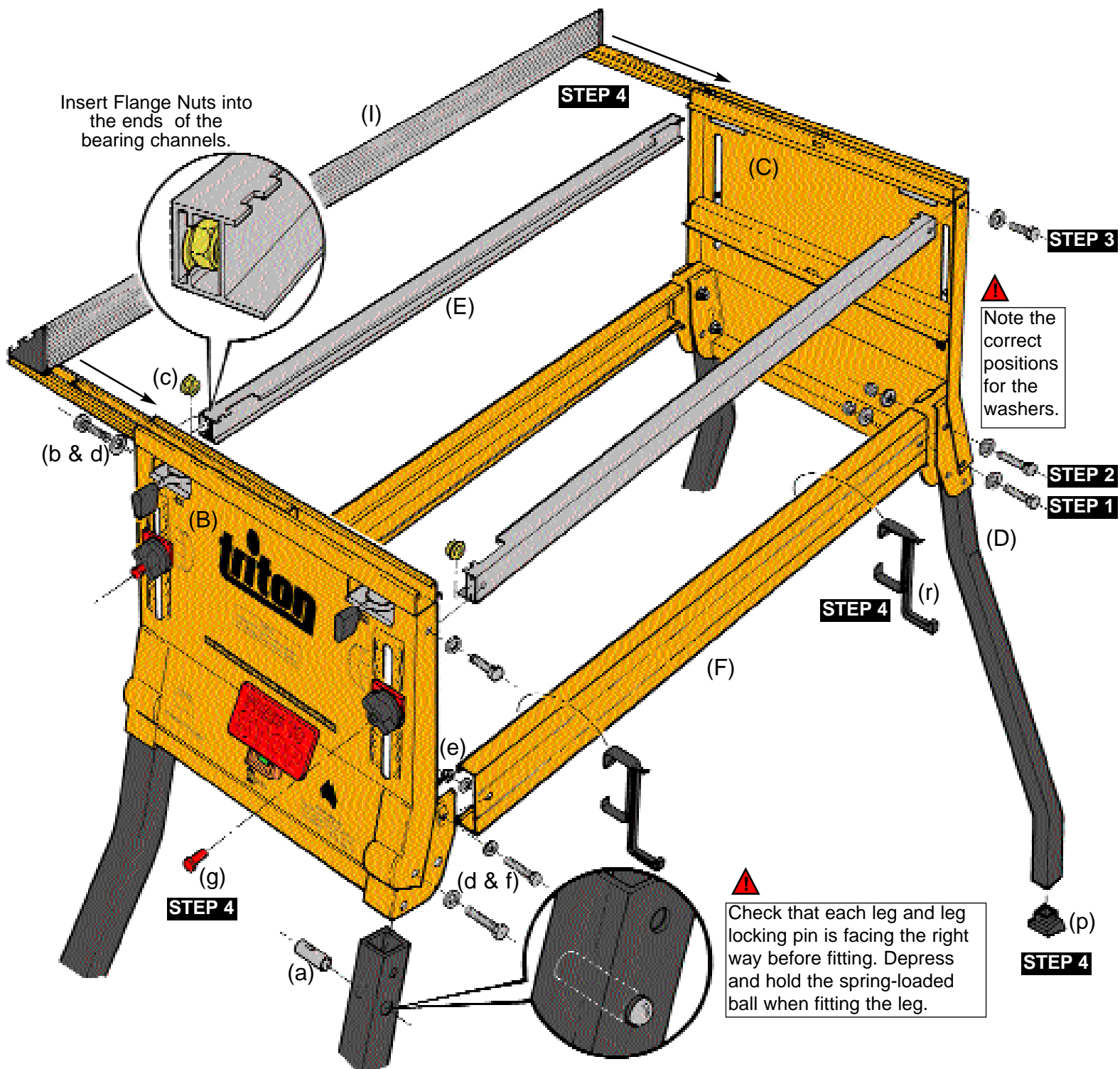

FENCE LOCKING: You only need use 2 locking levers - one at the front and one at the back. The locking position of the levers is factory preset. To adjust, simply loosen or tighten the nut at the bottom of each clamp assembly. The levers should reach at least the half way point in their arc of travel before tightening up. Lubricate the cam faces occasionally with light machine oil.

Fitting the Triton 235mm Precision Power Saw

For other brands of saw go to Page 6.

FITTING THE SLIDE CHASSIS

Place the Slide Chassis (L) in the bearing channels with the red plastic catch and red bearing spacers closest to the front panel (the switch box end) and the flanges upwards. Enter two bearings in the channel cutouts. ① Slide the chassis towards the rear panel and the other bearings will drop in. ②

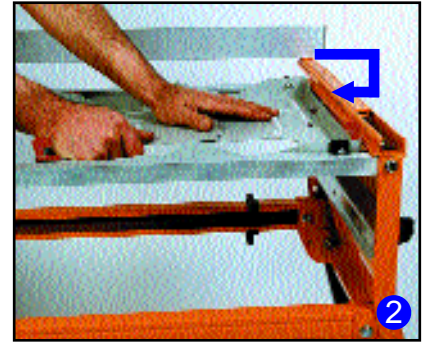
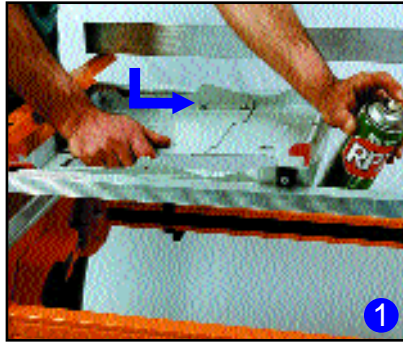

Spray the channels with RP7 or WD40 for a smooth slide.

FITTING THE TRITON SAW

Unplug your saw. Check that the blade is set at 0° and at full depth of cut.

Fit the Saw Alignment Cams (o) from below ③, holding the bases in the rectangular slots while you screw into them. (They cut their own thread.) Make sure the lines moulded on top of the cams are both pointing towards the rear panel. Tighten the screws until nipped gently. ④



FITTING THE SAW LOCATORS AND KNOBS

Fit the saw into the chassis with the alignment cams locating in the holes in the saw base-plate.

If the saw is set at full depth, the saw's spring-loaded guard will be held in the retracted position by the back edge of the chassis cutout.

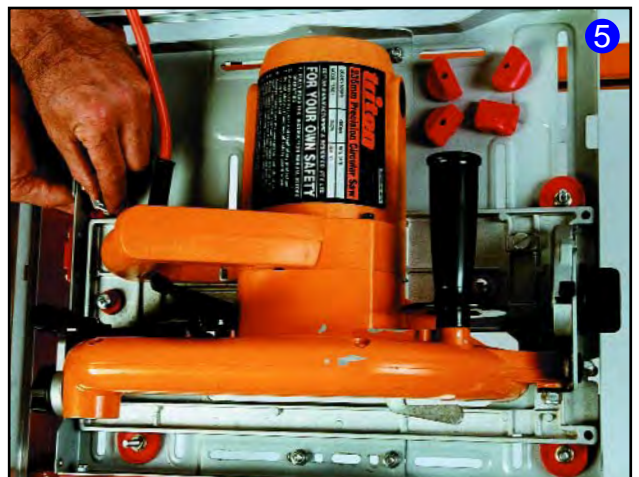

Break or cut the Saw Locators (k) and Knobs (l) from their moulding "tree" and carefully trim off any remnants with a sharp knife. Fit the saw locators in the slots shown in ⑤ using 4 Philips-head screws (m) and Flange nuts (n). The straight edges should be against the baseplate, but spaced away from it slightly to allow for final saw adjustment. (Use a spatula blade ⑥ or a piece of cardboard or metal about 1 mm thick as a spacer.) Firmly tighten the screws.

Screw the knobs on (they cut their own thread) until they just scrape against the top edge of the saw base-plate. ⑦ This tension is sufficient to hold the saw upside-down for final adjustment, and still allow the saw to be shifted sideways slightly using the alignment cams.

Check that the saw is securely mounted. Turn the slide chassis over, re-engaging the bearings in the channels. ⑧ & ⑨



Fitting the Triton 235mm Precision Power Saw (cont.)

ALIGNING THE SAW

Position the chassis halfway between the end panels. Adjust the fence in close to the blade and lock it. Make sure the blade is vertical by comparing it to the face of the fence. If necessary, loosen the nut holding the Blade Angle Trimmer (circled), and adjust the blade angle. Re-tighten the nut. ①

Use the saw's spanner ② or the Tube Spanner (s) to rotate the cams until the front and rear of the blade are *just touching the fence*, when it is at 0 mm. When satisfied with the position tighten the alignment cam screws. ③

Unscrew the front handle of the saw for better access to the front cam. Lower the blade for access to the rear one.



FINAL CLAMPING OF SAW

Double-check the saw position by now locking the fence at 0 mm, and trying to turn the blade backwards by hand. The teeth should *lightly* scrape against the face of the fence. ④ If not, repeat the above alignment.

This is a very important step, because it will ensure that your saw cuts are true, and that your fence scales are accurate, so take your time.

When satisfied with the position of the saw, reposition the saw locators hard up against the edge of the baseplate, as follows. Hold each knob against turning and loosen the screw about half to one turn. Push the saw locator into position, and firmly tighten the screw. ⑤

Turn the saw right-way up again and loosen the four knobs a couple of turns. Check that the saw cannot move sideways at all, and that all screws are fully tightened. Do up the knobs again, perhaps one turn beyond when they first scrape on the baseplate.

The saw is now set up, and is available at any time for hand-held use by simply loosening each knob half a turn and lifting the saw straight up. ⑥ If the locators are correctly fitted, the saw will go back into exactly the right spot each time.

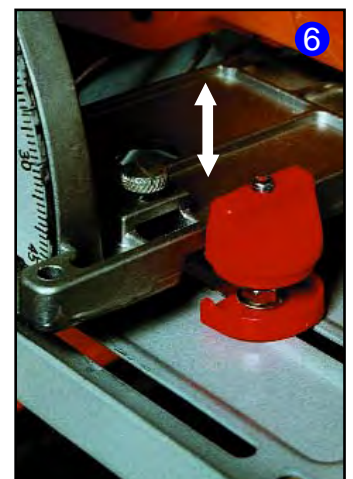
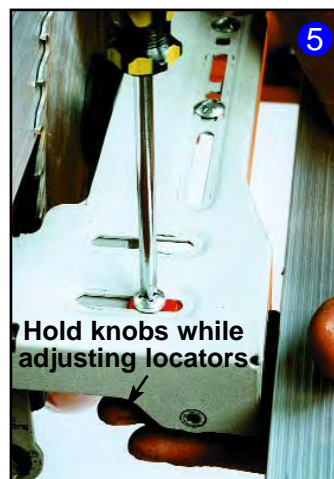
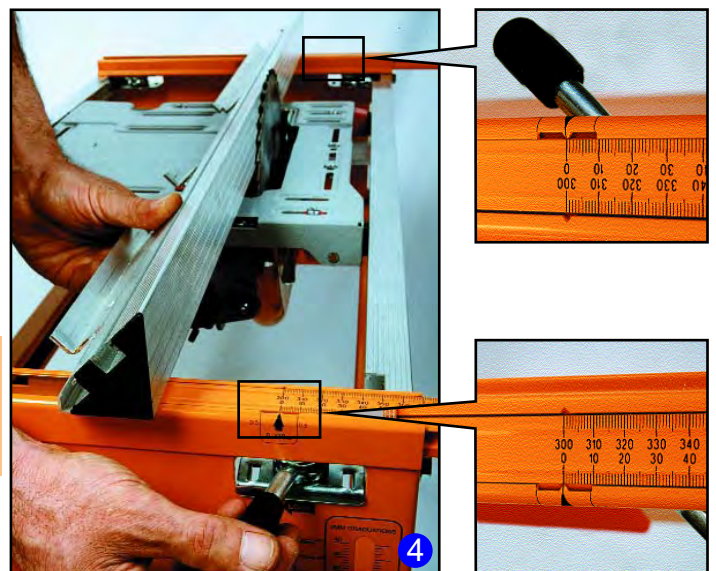

Triton saw owners, please skip to Page 8.

Fitting other brands of power saw

FITTING THE SLIDE CHASSIS

Place the Slide Chassis (L) in the bearing channels with the red plastic catch and red bearing spacers closest to the front panel (the switch box end) and the flanges upwards. Enter two bearings in the cutouts in the channels. ① Slide the chassis towards the rear panel and the other two bearings will drop in. ②

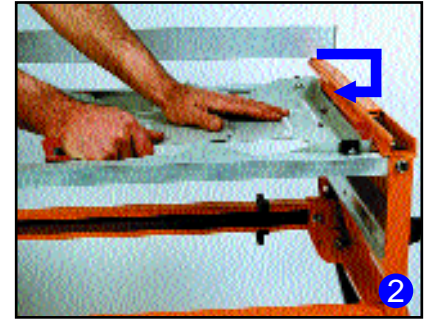
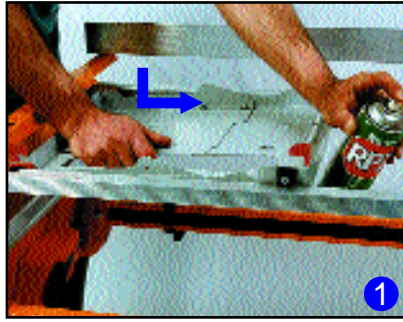

Spray the channels with RP7 or WD40 for a smooth slide.

ADJUSTING THE SLIDE CHASSIS

Check that your saw is unplugged, make sure the blade is set at full depth of cut, and is set at 0°. Study ③ below [especially if you have a small (184mm) saw] and follow steps 1 to 5 as required.

1. Adjust the slide chassis to the shortest length which will suit your saw, and provide widely spaced slot positions on the baseplate edges for fitting the clamps. (In shortening the chassis, do not overlap any of the mounting slots. If relocating the four coach bolts, use the square holes.)
2. Position the saw as far forward as possible on the chassis, but allow for finger access to the front wing-nut or knob on the saw.
3. Don't obstruct the sawdust opening in front of the saw blade.
4. Try to have the blade nut no more than 170mm from the front of the chassis.
5. For small saws, bolt a thin wooden spacer (eg. 6mm ply) behind the saw, to prevent possible saw movement.

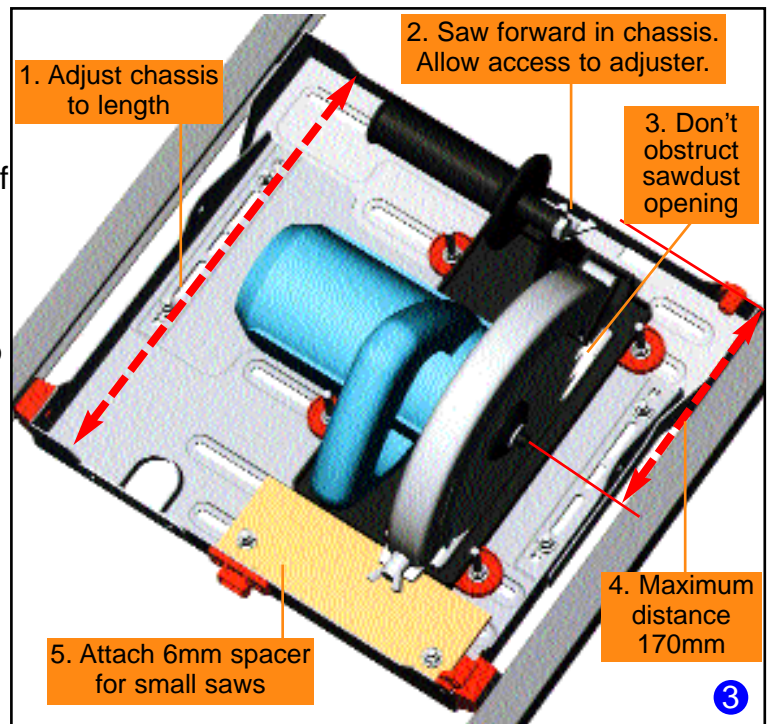

FITTING THE SAW LOCATORS

Break or cut the Saw Locators (k) and Knobs (l) off their moulding "tree", and trim any remnants with a utility knife.

Fit the saw locators in the selected slots, with their straight edges against the base-plate using four M6 screws (m) and Flange nuts (n). Firmly tighten up the screws using a screwdriver from below. ④



The spanner shown is optional, as the Flange nuts are self-gripping.

FITTING THE CLAMPING KNOBS

Screw the knobs on (they cut their own thread) until they scrape against the top edge of the saw base-plate. ⑤ Leave the knobs with the cutaway sections facing away from the saw.

Check that the saw is securely clamped, and turn the slide chassis over, re-engaging the bearings in the channels. ⑥ & ⑦

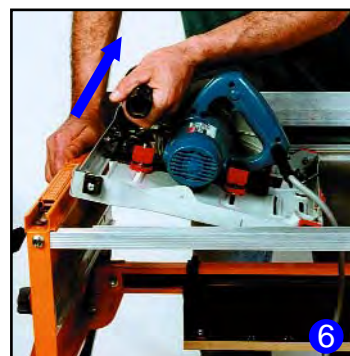

Fitting other brands of power saw (cont.)

ALIGNING THE SAW

Have the chassis midway between the end panels and lock the rip fence close to the blade. Compare the blade angle to the vertical face of the fence, and if necessary adjust the blade angle (using the saw's adjuster) until they are parallel vertically.

Hold the clamping knobs to stop them turning and use a screwdriver to loosen the clamp assemblies - *half to one turn only*.

Push the saw locators to move the saw. ① Do not push the saw itself as this may dislodge the clamps.

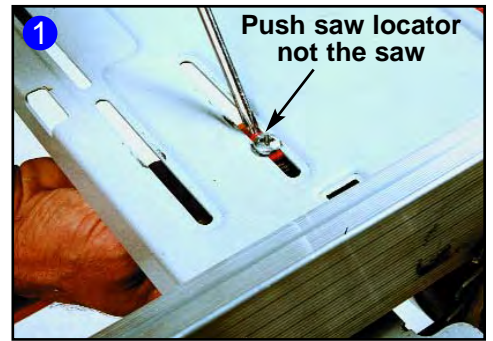

Lock the fence at "0" front and rear and align the saw so that the blade is *just touching* the fence. Spin the blade backwards by hand. The teeth should lightly scrape against the fence. ②

 This is a very important step, it will ensure that your saw cuts are true, and that your fence scales are accurate, so take your time.



FINAL CLAMPING OF SAW

Check that each saw locator is pressed up against the baseplate, hold the knobs against turning, and firmly tighten the four screws.

Remove the fence and turn the saw rightway up. Undo the clamping knobs a couple of turns and check that you cannot move the saw sideways at all between the locators.

Do up the knobs, and this time you can tighten them more firmly, perhaps one turn beyond when they first scrape on the base-plate. ③



If you tighten any one knob too much, and can't loosen it, undo the other three knobs by half a turn, remove the saw and undo the knob.

Turn the saw upside down again, re-fit the fence and double check that the blade is still at "0".

The saw is now set up, and is available at any time for hand-held use by loosening the knobs half a turn and lifting the saw straight up. If the locators are correctly fitted, the saw will go back into exactly the same position each time. ④

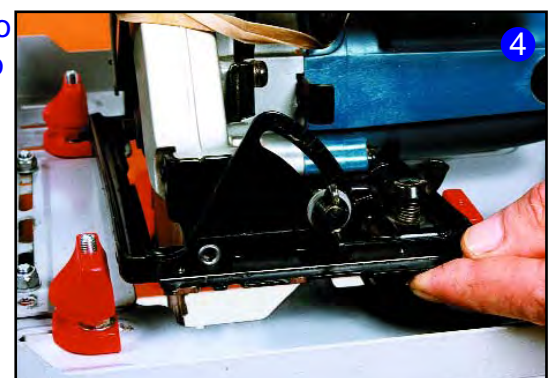

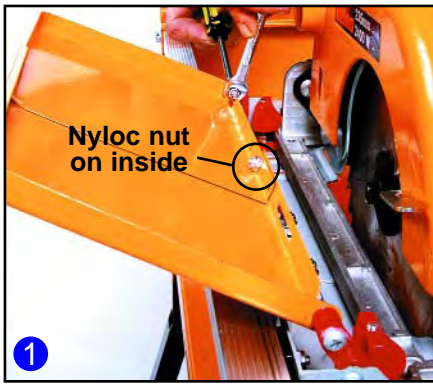

FITTING THE SIDE GUARD

Slide the two sections of the Side Guard (K) together until they fit between the pivot brackets on the slide chassis. Loosely fit the short Philips-head screw (i) and a Nyloc nut (h) to hold them together.

Fit the two longer Philips-head screws (j) and Nyloc nuts through the pivot brackets and into the guard flanges. ① Tighten until the guard is firm, but still free to pivot. Finally, tighten the screw holding the two halves together.

FITTING THE TRIGGER STRAP

! Before fitting the trigger strap (q) always ensure that the saw is disconnected from the power and that the switch on the Workcentre front panel is in the "OFF" position.

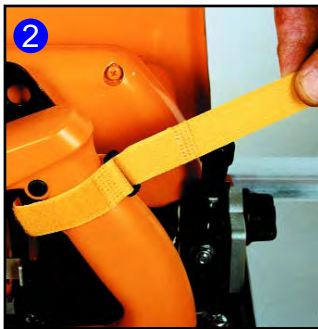

Wrap the Trigger Strap (q) around the handgrip with the furry side facing outwards. Pass the strap through the buckle, until the security loop has passed through. ② If your saw has a safety lock-out button press it and then tighten the strap until the trigger clicks "ON".

Wrap the free end of the strap around the handgrip. ③

With most saws, the strap can be slid on and off the saw trigger, without undoing it each time.

Do not leave the trigger strap permanently locked on. When you have finished work for the day, release the strap and allow the spring in the trigger to relax.

FITTING THE TABLE

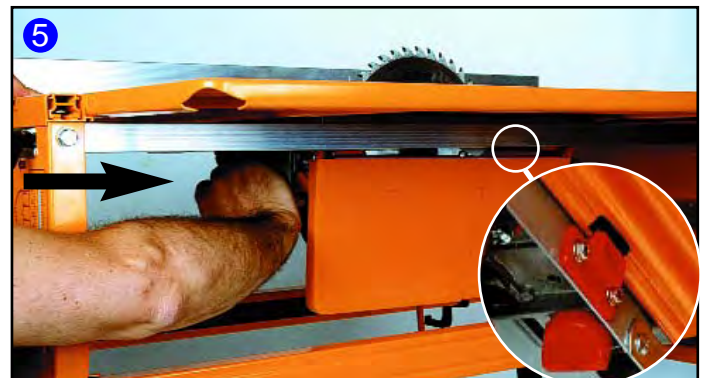

Turn the slide chassis upside down. Position it roughly half-way between the end panels. The front of the saw must be facing the front panel (switchbox end).

Lower the Table (A) over the blade, with the four T-slots closest to the rear panel. ④ Line up the arrows on the edges of the table with the scale pointers on top of the end panels. Push the table latches to the "LOCK" position. The red indicators disappear from view when the latches fully locate.

Reach underneath and push the slide chassis towards the rear panel until the red catch (shown in the inset view on ⑤) "clicks" home and locks the chassis underneath the table.

FITTING THE OVERHEAD GUARD & SUPPORT



Loosen the knob on the Overhead Guard (J) to remove the Guard Support from its shipping position. Fit the support to the centre table slot, using the cut-outs at the end. Ensure the saw blade is adjusted to its maximum depth, then position the support about 12mm behind the blade and lock it in by pressing the locking lever down. ⑥

Lubricate the entry if it's a tight fit. Check the guard support is reasonably square to the table, and adjust it if necessary by pushing evenly with your hand or a block of wood. ⑦



Hold 2 straight pieces of wood lightly against the blade. ① The overhead guard support should fit between the pieces.

If not you may have to adjust the saw position slightly. This is only likely if you have a very thin kerf blade (2.0 - 2.2mm cut width)

Fit and lower the guard. ② Spin the blade by hand before connecting the power to ensure it is not touching anything.

! Always make sure the blade is at full height, the guard is fitted, and the table is locked to the end panels before switching on the power.

Check that the teeth on your blade are pointing in the same direction as the etched symbols on the guard. If not, you have incorrectly fitted the blade to your saw.

CONNECTING THE POWER

Make sure the switch is "OFF", plug the saw into the switch box, and bring power to the switch box via a 10 Amp extension cord.

Press the green switch with your finger to switch the power "ON". ③ Tap the stop plate with your hand or knee to switch "OFF". ④



Switch the power on and off and watch the blade. If it quivers sideways on start-up it's a sign of a worn arbor in your saw, or excessive slack in the mountings between the motor and baseplate.

If the blade vibrates significantly at full speed or on slow-down, it's either buckled or not seated properly on the arbor. Check the flatness of the blade with a straightedge, check the fit of any arbor-reducing washers, and check for resin/sawdust build-up on the arbor or flange washers.

A slight quiver is generally noticeable on slow-down in most blades, and shouldn't affect your cuts.

FITTING THE BEVEL GUIDES

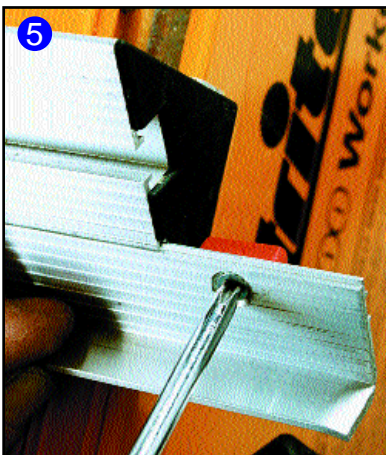

Reverse the fence so that when fitted to the Workcentre from the left hand side, the 45° face is closest to the blade.

To fit the Bevel Guides (N), loosen the Phillips-head screws slightly, engage the lip at the top of each guide in the mating section of the rip fence, and guide the red plastic clamping feet into the T-slot. ⑤

The plain bevel guide fits in front of the blade. The notched bevel guide fits at the rear, with the small tab locating between the blade and the overhead guard support. (If your power saw is fitted with a riving knife remove the small tab (circled) from the guide using a hacksaw.) ⑥

Tighten the Phillips head screws. The function of the guides is described on 20.



SETTING UP THE CROSSCUT MODE

Remove the overhead guard and rip fence and store them as shown on Page 28.

Remove the table and place it to one side for the moment.

Adjust the height of the aluminium table support rails inside the front and rear panels, to suit your saw. ①

The rails are meant to be a snug fit inside the panels and may need a sharp tap to free them. The adjustment is a bit easier without the table in position.

The four most common saw sizes are printed on the end panels for reference. In ① the table height is being set for a 235 mm (9 1/4") saw. The top edge of the red indicator is the reference.



Turn the saw right way up but leave two of the bearings on top of the channels. ② Slide the table in from the side until the centre slot is directly below the blade. Lock the table by pushing the latches fully home into the cut outs in the table support rails. (The red indicators on the latches must fully disappear from view).

Slide the chassis to the rear panel and the two free bearings will drop into the channels.

! Always make sure that all four bearings are back inside the channels before making a cut.

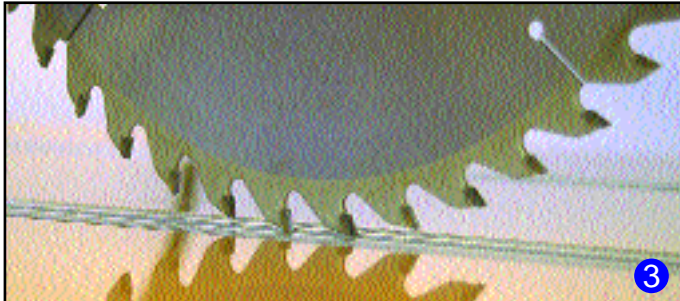

The tip of your blade should be just entering the slot (by 1 - 2 mm) and it should be approximately central in the aluminium track. ③ If not, see Saw Slump adjustment on Page 13.

Leaving two bearings out of the channels enables you to slide the table in from the side without the tip of the blade scratching the paintwork on the table. Another method is to raise the saw blade a little, and then lower it again when the table is in position.

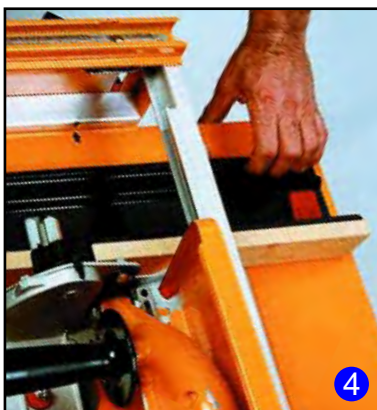

FITTING THE CROSSCUT FENCE

Fit the Crosscut Fence (H) to the four T-slots in the table, with the MDF sub fence closest to the saw. Pull the fence towards the rear panel as far as it will go. ④

To release the fence, hold down each red plastic catch while pushing the fence towards the saw. ⑤

The fence may be a little tight - especially when new. Do not loosen the screws fastening the four plastic feet. Rather use a block of wood to gently tap the fence home. If you do have to loosen the screws, 1/4 to 1/2 a turn should be enough. The plastic feet are difficult to re-seat if undone.

USING THE RIP FENCE SCALES



Each end panel has two scale pointers exactly 300 mm apart. For cuts in the range 0 - 320, (with the fence on the left of the blade) use the pointers which are closer to the blade. Line up the arrow point and read the lesser figure on the scale arms.

For wider ripping in the range 320 - 620mm simply move across to the outer scale pointers and read the higher figure.

In ①, the fence is set at 100mm using the 0-320 mm pointers. It would be 400 mm if you were using the outer pointers.

The edges of the pointer cutout, and the two fine 0.5 lines are 9.5mm from the arrow-point. Use them as a vernier in setting 0.5 mm increments, to avoid guessing the mid-point between graduations.

USING THE RIP FENCE ON THE RIGHT



Set on the left of the blade, the fence gives the maximum 620mm capacity. However, if you prefer to use the fence on the right, the self-adhesive Scale Pointer Labels (u), will provide the zero position.

Fit the fence on the right and touch it against the blade. Check it is **exactly** parallel by comparing the readings at the front and rear panels - about 183mm / 483mm. Lock the fence, turn the blade backwards by hand and the teeth should lightly skim the fence.



Remove all dust, and apply the labels to the specified end panels directly in line with the 0 marks on the scale arms.

The labels wrap inside the tracks to prevent peeling off. Lines printed on the labels show where to fold. ② Once they're stuck in position, slide the fence away to fold the tops of the labels inside. ③

You can reverse the bolt and knob in the overhead guard for closer fence access if using the fence on the right.

FITTING THE GUIDED PUSHSTICK AND SIDE PRESSURE FINGER



The Guided Pushstick slides in the T-slot on the 45° face of the rip fence. The swing-arm rests against the vertical face, and should pivot freely. ④

The lock direction of the swing-arm can be reversed (depending on which side of the Workcentre the rip fence is used) by firmly pressing the direction switch.

Clip the Side Pressure Finger to the holder, noting the correct orientation of the bulge ⑤. Snap the assembly into the left-hand corner of the protractor. Pull the finger out to lock. Press the trigger and push the finger in to retract.

In use, the finger is extended and the protractor locked at an appropriate angle to press the wood against the fence in front of the blade. The protractor must be locked in it's slot by loosening the locking knob, rotating the pointer to the \square position, and re-tightening. (See also ⑥ Page 12)

A spare finger is included in case you accidentally cut one.

TEST CUTS - Tablesaw Mode



It's important that you perform these test cuts, in the order laid out in these two pages.

First, check your square - many are inaccurate. Use a board with a straight edge. Press the square firmly against it, and use a sharp pencil to trace the blade on the board. ① Flip the square over, press it against the straight edge again, and compare the blade to the pencil line. ② Any error in your square is seen as doubled.

CROSSCUTTING TEST

Take a **straight** piece of wood 30 - 45 mm thick and at least 300mm long. Lower the overhead guard to about 5mm above it.

Fit the protractor to the left or right table slot, and check that it slides freely from end to end. Spray lubricant such as RP7 on the slider strip. Set the protractor at exactly 0°, and tighten both knobs.

Hold the wood firmly against the long sand-paper face of the protractor, and push the protractor down lightly for best guidance in the slot. ③ Feed the wood smoothly into the blade.



When the workpiece is past the back of the blade, switch off by bumping the STOP plate.

If the *back of the blade* re-cuts or burns the workpiece, your saw is probably slightly skew on the slide chassis, and may have to be adjusted slightly. Or your blade could be buckled.

CHECKING THE CUT



For an error **ALONG** the cut, ④ re-adjust the protractor angle slightly and repeat the test. (Hold the square against the edge that was against the protractor face).

For an error **ACROSS** the cut ⑤ (with the square against the face which was on the table) adjust the blade angle slightly.

If your saw does not allow you to get the blade completely square to the table, either file out the curved slot in the saw's quadrant, or attach shim packing between the narrow edge of the saw baseplate and the slide chassis to angle the whole saw slightly. The Triton Saw Stabilising Bracket (see next page) is advised if the blade reaches 90°, but then slumps away because of saw flex.

RIPPING TEST

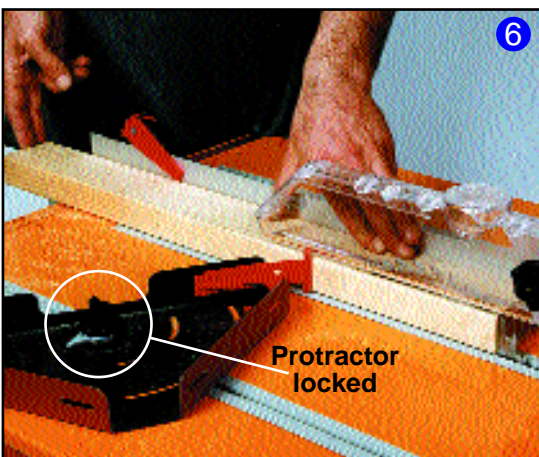

⑥ Take a straight piece of wood at least 70mm wide and 500mm long, and adjust the overhead guard to about 5mm above it. Lock the rip fence exactly parallel to the blade at a fence setting to give an off-cut of say 5 mm.

Fit the guided push stick and side pressure finger as shown in ⑥. The protractor must be locked in the slot (as circled) about 20mm in front of the blade, and at an angle to gently flex the finger. Avoid applying too much pressure.

Hold the wood firmly down on the table and feed it smoothly. Keep pushing it - without pausing - until it is fully past the back of the blade. Use your hands while it is safe to do so, but finish off using the guided push-stick to push the wood through.

If the back of the blade re-cuts or burns the workpiece, either the fence was not parallel, or the saw needs adjustment on the slide chassis, or the blade is buckled.

If the wood tightens up between the overhead guard support and the fence, switch off and wait until the blade stops before withdrawing the piece. Increase the rear fence setting *slightly* and repeat the cut. An extra 0.5-1mm on the rear fence settings is okay to prevent jamming.

TEST CUTS - Crosscut Mode

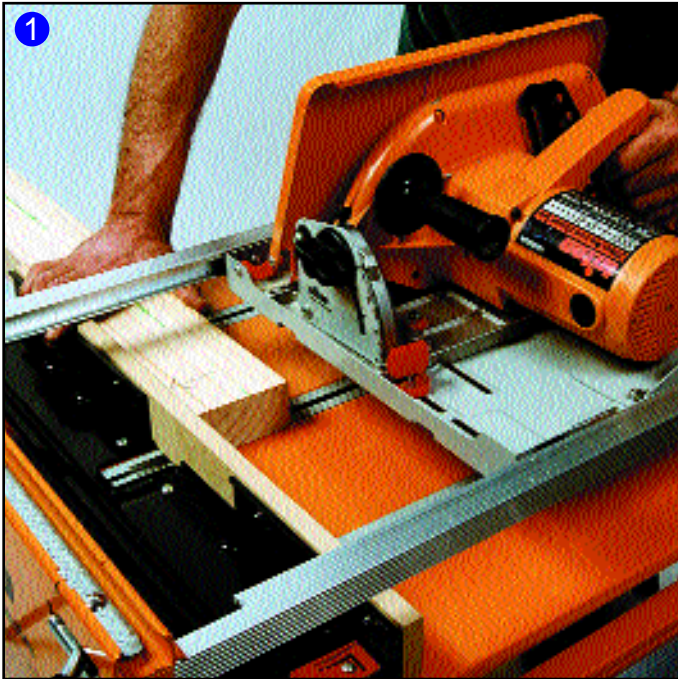

Unlock the trigger strap and use the trigger normally. **With the power off**, push the saw from end to end, to check that the blade tip is clear of the table slot.

Take a straight piece of wood, at least 300 mm long, hold it with your right hand, and push the saw with your left. **1** Hold the wood firmly, pushing it down on the table and against the fence. Check the blade is not touching the wood before switching on.

Gently and smoothly make the cut, without forcing the saw. If you have to push hard, or if there's a burning smell, sharpen or replace the blade.

Avoid pulling a spinning blade back towards you. The offcut - especially a small one - could be re-cut by the back of the blade, with a bang!

If the blade marks the work piece as it is slowing down, simply pull the wood out sideways once you've cut through.

If you can't complete your cut, because the blade tip doesn't quite reach the crosscut fence, either raise the table slightly, or move the saw slightly forward on the slide chassis, or pack out the MDF subfence.

Remove any uncut fibres, and check for accuracy as described earlier.

For an error **ALONG** the cut, check that the fence was fully home in the T-slots and that there was no sawdust between the wood and the fence. Always hold the square against the edge that was against the fence.

For an error **ACROSS** the cut, you probably have some "saw slump", or flex between the saw motor and its baseplate. You have four options to rectify the problem:



1. Build a compensating angle into the table position, so that the table remains square to the blade. In **2**, the table support rails are set at 72mm on one side, and 80mm on the other.

2. Obtain the Triton Saw Stabilising Bracket **3** (ABA020) which provides a strong brace for the motor, yet still allows easy blade height and angle adjustments;

3. Upgrade to a saw with better motor mounts;

4. Adjust the blade angle slightly every time you convert between modes.



If there's a step in the cut, or a high spot or a burn mark, see *Arbor float* on Page 14.

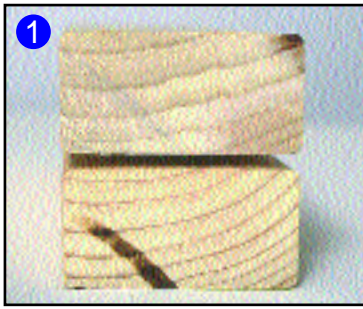

ARBOR FLOAT

If your cuts have ridges, burn marks or high spots **1**, the saw is mounted skew on the slide chassis, or it has arbor float, or the blade is blunt / buckled. Check for arbor float by unplugging, gripping the blade or blade nut, and pulling in and out in the direction of the shaft. **2** Any movement is undesirable.

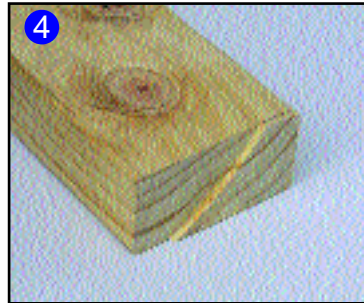
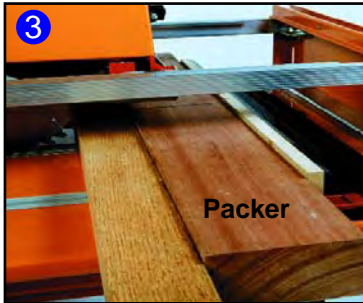

For perfectly square cuts, you may have to repair or upgrade your saw.

You might reduce the problem by placing a parallel-sided packer between your work and the fence. **3** Also try shaving cuts, **4** where the second (shaving) cut removes say 1 mm of material, putting less load on the arbor.

SELECTING A CIRCULAR SAW

A float-free arbor, and firm mountings between the motor and baseplate, are most important.

Check for arbor float as described above. To check the mountings, hold the baseplate down on a flat surface, and see how much you can move the motor up and down. Test at different height and angle settings.

Most circular saws have a height adjustment pivot at the front, with the locking lever/knob behind the motor. They are the preferred type. Vertical lift (plunge-type) saws should only be fitted if they remain rigid and accurate throughout their height and angle adjustment range.

A 235mm (9 1/4") saw is best for heavy work, requiring a large depth of cut or extra power. 208mm (8 1/4") or 185mm (7 1/4") saws are quite adequate. If considering upgrading your saw, the Triton 235mm Precision Power Saw is highly recommended.

SELECTING A SAW BLADE

This is one of the key factors for square, smooth cuts with a minimum of splintering. We strongly recommend tungsten carbide tipped (TCT) blades.

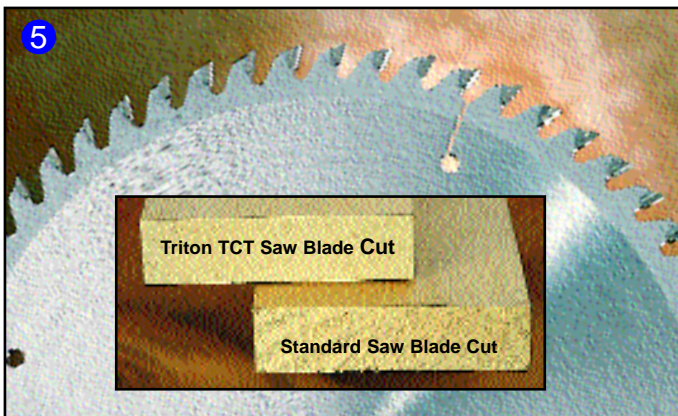

Triton Premium TCT Saw Blades have been expressly designed for the Workcentre and have a unique tooth design. They cut very cleanly, reduce arbor float-related problems, and minimise splintering, especially in veneered boards.

The number of teeth depends on the work you'll mainly be doing: for crosscutting, the more teeth the better. A 184mm saw should have 30 - 40 teeth and a 235mm saw should have 40 - 60 teeth.

Ripping generally requires fewer teeth, (20 - 32 on a 235mm blade), with larger gullets behind the teeth to help clear the longer curls of saw dust created when ripping natural timbers.

If you can only afford one blade, we suggest more teeth rather than fewer. Just slow down the feed rate when ripping natural timbers.

OPERATING - Tablesaw Mode

! It is important that you practice the following safety rules at all times.



Always keep fingers well clear of the blade. Fit the overhead guard as low as possible, to just allow the work to pass under. Where possible use the guided pushstick and side pressure finger. **1**

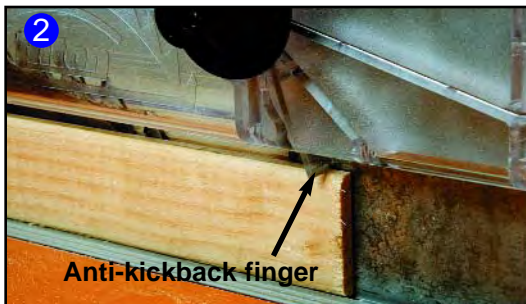

Never reach over or behind a spinning blade. Most accidents occur when reaching over an unguarded or poorly guarded blade to remove off-cuts. Push off-cuts away with a stick, or switch off and wait until the blade has stopped spinning before removing them.

Always use the safety guard when through ripping. Position the guard support at least 12mm behind the blade at all times. The guard acts as a “splitter” and a “hold-down”, to prevent the wood from flinging towards you. Lower the guard so the anti-kickback fingers are lightly flexed. **2**



Always use the rip fence or protractor. Never attempt a freehand cut (e.g. following a pencil line). The blade can fling the wood towards you with great force if you twist it even slightly during the cut.

Always set the fence parallel to the blade, and lock it securely at both ends. You must **never** angle the fence to the blade for rip cuts. **3** Your wood will jam against the blade, and could be flung out towards you.



Always control the piece between the blade & fence. If uncontrolled, this piece could get damaged by the side of the blade, or be flung out towards you - especially with short workpieces. Use the pushstick rather than your fingers, unless you have good hand access between the fence and the guard.

To rip a 70mm piece down to 60mm, it's much safer and more accurate to set the fence at 60mm, and have the offcut fall harmlessly aside, **4** than to set the fence at 7mm (allowing for a 3mm saw cut) and have a narrow offcut trapped between the blade and the fence. **5**



Always wear eye & ear protection. Serious accidents occur when operators get sawdust or chips in their eyes during a cut. Use ear muffs, and a dust mask or a dust collection system.

For generally smoother cuts with less splintering, lower the blade until it is just a few millimetres through the work. You can further improve cut quality by ripping 1mm oversize, then resetting the fence and making a finishing cut, **6** putting less load on the saw and blade.

Set up the Workcentre on level ground, and kick the legs diagonally outward to ensure it is stable. Check that it is correctly set up (as described on Page 12 Ripping Test).



RIPPING LONG PIECES

When ripping long pieces which will overhang the rear of the table by more than half their length, either have a friend help you, or rig up a “tail-out” support. The Triton Multi-Stand (MSA200) is ideal for this as it will not steer the work away from the fence. ①

If using a conventional roller stand make sure it is exactly perpendicular to the direction of feed, or it *will* steer your work.

Try to keep the workpiece moving, even slowly, during a long rip. Pauses can cause slight steps in the cut. A finishing cut should help.

RIPPING LARGER SHEETS



Set the fence on the left, and lock it parallel, although you can add between 0.5 - 1 mm to the rear fence setting for clearance.

Lower the overhead guard as a “hold-down”, lightly flexing the anti-kickback fingers. Push the work against the fence with the left hand, and support the off-cut with your right. Keep both hands on your work and switch off with your knee when you finish the cut.

The Triton Multi-Stand is ideal for supporting larger offcuts. You can clamp a length of wood in the head for even better support. ②



For ripping very large sheets, consider the Triton Sliding Extension Table (ETA200) or use the saw hand-held. Remove it from the chassis, undo the trigger strap, and check the saw guard. Clamp a guide to the workpiece, which should be supported securely on packers.

When ripping thin, flexible material wider than around 500mm, you will need additional support, such as the batten shown ③ to stop the front corner of the material becoming snagged by the rear fence arm.

RIPPING THICK WOOD



Double your maximum depth of cut by turning the wood over, end for end, and making a second cut. If the edges were dressed square, the two cuts should be in line. ④

The overhead guard cannot be fitted for the first cut. Prevent the wood from riding up on the blade and **feed slowly**. Be careful of your hand positions. They must stay clear of the blade even if the wood kicks back. The guard must be fitted for the second cut.

Adjust the blade height so you'll make two equal-depth cuts... eg. set it at 46mm for double ripping 90mm material



PLANING AN EDGE

A tungsten carbide tipped blade or a planer blade can give an excellent finish on poorly dressed, weather-stained or painted material. Measure the workpiece - say 90mm wide - and set the fence at 88 or 89mm, to remove 1 or 2mm.

Use the side pressure finger and guided push-stick to hold and control the workpiece, especially when planing narrow pieces. ① Keep the blade as low as possible. Try not to pause during the cut, and do a finishing cut if desired at a slightly narrower fence setting.

Never attempt planing cuts which involve moving the fence very close (1-2mm) to the blade.

For planing a bowed workpiece, attach a straight piece of scrap to the bowed piece so it overhangs one edge for the full length. (Use brads or strong double-sided tape). Run the scrap along the fence, dressing one edge of the bowed piece straight. Remove the piece of scrap and then run the straightened edge against the fence.

PLANING A WIDER FACE



If planing a face wider than your maximum depth of cut, set up as described above, and make two planing cuts, turning the workpiece over (end-for-end) after the first cut. Use the side pressure finger to hold the workpiece against the fence. ②

Try to make both cuts of similar depth. i.e. plane a 90mm wide face with two cuts of around 46mm.

You will probably not be able to use the overhead guard for the first cut. You must keep the workpiece well controlled, and be very careful of your hand positions. They must stay clear of the blade even if the wood kicks back. The guard must be fitted for the second cut.

EDGE REBATING

By lowering the saw blade and adjusting the fence, you can make a wide variety of rebates.

When cutting wood which is rectangular in profile always make the first cut with the wood on edge ③ and the second cut on the flat. ④ Otherwise, if rebating narrow wood, the workpiece could end up balancing unsafely on a narrow rebate after the second cut.



You cannot use the overhead guard on these cuts, so make sure your hands stay clear of the blade, even if the wood kicks back.

Most rebates create a narrow off-cut. You should avoid trapping the off-cut between the blade and the fence by doing the cut as shown in ④. If you do have a narrow offcut between the blade and the fence, do not stand directly in line with the blade. The off-cut could be flung towards you at high speed.

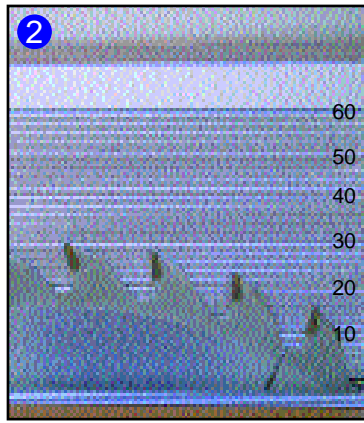

To set the blade to a desired depth of cut, mark it on a piece of wood. Lay the wood beside the blade, leaving both hands free for adjusting the saw. ① Or use the 2mm & 10mm calibration marks on the face of the rip fence for setting blade height.

In ② the blade is set to 30mm, the third deep groove up from the table. (These calibrations are approximate only and should be verified by a test cut on some scrap.)

TONGUE & GROOVING



Study the previous section on Edge Rebating. Make two identical rebates from opposite faces of the workpiece, leaving you with a central tongue. Complete the tongue with the wood lying down flat as shown in ④, Page 17.

To make a matching groove, move the fence outwards (by one blade width from the tongue setting) and make two cuts from the opposite faces. ④

Raise the blade 0.5mm before cutting the groove, to allow for glue and to ensure a tight joint.

Always make the first two cuts into the narrower edge of the workpiece ③, and the two final cuts with the workpiece lying down flat (as in ④ on Page 17). Otherwise, your workpiece could be left balancing unsafely on the narrow tongue after the final cuts.

Test fence and blade height settings on short off-cuts of the wood you'll be using. If joining long pieces (which might not be dead straight), make the test pieces a slightly loose fit. Otherwise you could have problems cramping the job up tightly.

EDGE WORK ON THIN MATERIAL

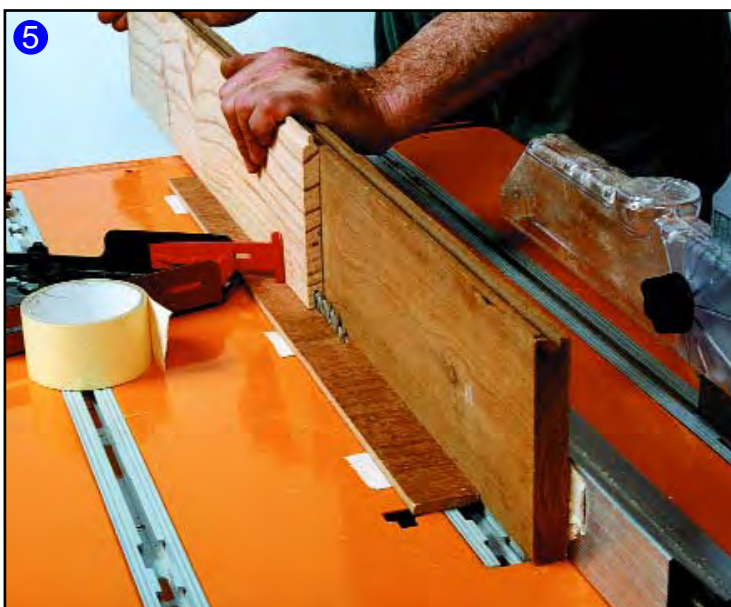

If rebating or tongue & grooving very thin boards, the workpiece could be unstable standing on its narrow edge.

Attach a suitable height sub-fence to the rip fence for extra vertical support. (Use strong double-sided tape - 50mm carpetlaying tape is ideal - or countersunk bolts and nuts by removing the fence end caps.) If necessary use a piece of ply or hardboard with a thin slot in it for the blade. Securely tape it to the table as a mask, and have the blade protruding as little as possible. ⑤

You cannot use the overhead guard so be very careful with your hand positions.

WORKING ON ENDGRAIN



Attach a straight, board (100-150mm wide and 25-35mm thick) to the rip fence as described above.

Make a guided “rider”, using an offcut of the same board with cleats on both sides to slide snugly along the top of the board. ① Attach a pusher block to hold the workpiece vertical as you push it over the blade. Or clamp the workpiece to the pusher block.

If making splined right-angled joints ② or splined butt joints ③, cut all pieces from opposite faces, without changing the fence setting, to ensure the grooves line up.

When working with narrow wood, make sure the workpiece cannot jam in the blade slot. Use a mask taped to the table as in *Edge Work on Thin Material*, Page 18.

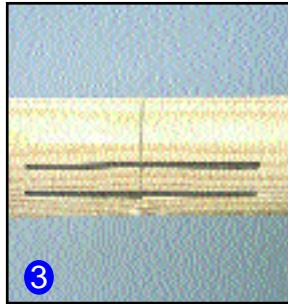

TAPER RIPPING

NEVER ANGLE THE FENCE TO THE BLADE FOR TAPER RIPPING. Taper cuts cannot be made in this way and are extremely dangerous if attempted.



To rip tapers, the workpiece must be angled *by a guide that travels parallel to the blade*.

For short tapers (400-500mm long), you can use the protractor as your guide. The right hand table slot can be used for wider pieces. Hold the workpiece tightly against the sandpaper face and down on the table.

Make sure the overhead guard is fitted and correctly lowered, because your fingers will be passing quite close to the blade. ④

The width of material you can handle is limited and you may have to attach a packer to the protractor face to achieve a desired cutting line. The workpiece should be attached to the packer (using double sided tape or mechanical fasteners). Or fit a rear pusher block to the packer.

Rehearse these cuts with the blade dropped below the table level, and the overhead guard removed, to check your hand positions. Do not rely on the first few millimetres of track at either end of the table for completely accurate guidance.

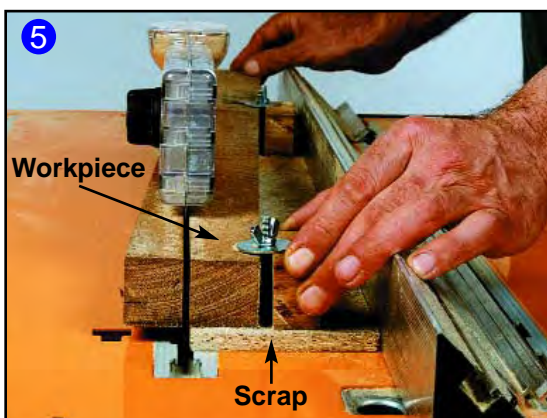

For longer or wider tapers, use a thin piece of parallel-sided scrap as your guide. Attach the workpiece at the desired angle. Slide the scrap against the fence, which is set parallel to the blade. If the scrap was cut to say 100mm wide, set the fence at 100mm, to give good back-up support directly beside the blade.

Use brads or strong double-sided tape to attach the workpiece, or use countersunk bolts, wing-nuts, large washers and offcuts to clamp it to the scrap as shown in ⑤.



BEVEL RIPPING AT 45°

Turn the rip fence around and turn the fence arms around so that they enter the end panel tracks first. The 45° face of the rip fence will now be facing the blade with the fence still on the left.

Fit the overhead guard support about 30-32mm behind the blade.

Make sure the blade is at full height and that the slide chassis is locked underneath the table.

Move the fence in close to the blade and lock it at about 11mm. Loosen the Phillips-head screws and adjust the bevel guides so they give your workpiece maximum support in front of and behind the blade, and behind the overhead guard support.

With the power disconnected, spin the blade by hand to make sure it clears the guides.

Fine-tune the fence settings to ensure that the left hand face of the blade is exactly lined up with the internal bottom corner of the guide. This is important for cutting to a perfect “feather” edge without losing any width of workpiece.

Fit and adjust the guard so the workpiece can pass underneath. **1**



Your hand positions, and the amount of pressure you apply, are important in achieving straight, step-free bevels. Avoid pressing down where the workpiece is unsupported - for example at the very end of the cut, when the workpiece moves off the front bevel guide. Adjust the front guide so that the blade enters the notch. **2** It will help prevent “dipping” at the end of the cut. Practice on scrap material first.



If bevelling narrow pieces, the guides give no support while the wood is alongside the blade. Clamp a straight piece of wood squarely to the workpiece, **3**, and use it as a guide running along the top of the fence to support the workpiece at all times.

The Workcentre fence should only be used for cutting pieces of a manageable size - up to say 300mm wide. For larger pieces either obtain the optional Bevel Ripping Guide (BRA200) **4** or use the saw hand-held with the work supported on battens.

Bevel cuts in the full range 0 - 45° can be made in the Crosscut mode (Page 26), provided the workpiece is less than say 500mm wide (depending on your saw size.)



CHAMFERING AT 45°

You can also use the guides for 45° chamfering. Retract the front guide, so that you can move the fence outwards - say to a setting of 20mm. Lock it exactly parallel.

Observe the above instructions regarding hand positions and hold-down pressures. **If chamfering thick wood, adjust the front bevel guide all the way in to give maximum support beside of the blade. 5**



CROSSCUTTING IN TABLESAW MODE

Make sure the protractor slides freely in the slot, with both knobs tightened and the protractor set at 0°. Lubricate the slider strip, using spray lubricant such as WD40. Lower the guard to about 5mm above the wood.

Hold the wood firmly against the long face of the protractor, and down on the table, and move it smoothly past the blade. ①

Keep fingers well clear of the blade. Make sure the workpiece is of manageable length, and that the offcut you'll create is well supported after the cut.

Having the protractor behind the work ① is the preferred operating position, but it limits your crosscut capacity to around 140mm. Having the protractor in front of the work ② increases the width capacity to around 340mm. For even wider pieces, you should convert to the crosscut mode.



The first few millimetres of protractor travel in the slots (near the entry holes) should not be relied on for completely accurate guidance.

NEVER SET THE FENCE AS A STOP ③. The offcut trapped between the blade and the fence is uncontrolled, and will be flung out towards you, causing possible injury and damage. To do this safely, read on.



MULTIPLE CROSSCUTTING

If you want to crosscut a number of short pieces to the same length, you *can* safely use the fence as a stop, but you must have a spacer at least 19 mm thick attached to the front of the fence. Set the fence to the desired length of the pieces, plus the thickness of the spacer. ④

By attaching the spacer (using double-sided tape) in front of the blade, the cut-off pieces have room to move, and are not trapped between the blade and the fence.

If you are cutting very small pieces, you may find that they tend to vibrate along the side of the blade, suffering slight re-cut damage. It is better to cut them against a backstop, as described below.

MULTIPLE CROSSCUTTING AGAINST A BACKSTOP

Attach a sub-fence to the protractor, and clamp a stop block to it. By fully backing up the workpiece and the off-cut, you can keep firm hand control over both pieces. ⑤ For very small pieces you can control the off-cut with a "hold-down" finger fitted to the sub-fences or to the stop block.



For the sub-fence, select a piece of wood (70 x 35, say) which when laid flat is low enough to use the overhead guard, and yet still strong after the blade cuts part-way into it. ⑤

After finishing each cut, make sure you pull the protractor back towards you, well clear of the blade, before removing the off-cut.

TENONING



Lower the blade. Place the end of the workpiece against the fence, and hold it against the protractor, set at 0° . Make a series of cuts, moving the workpiece away from the fence by one blade-width after each cut. Repeat on the other three faces, and you should have a perfectly central tenon. ①

If using a router to make the mortices, select the cutter first (say 19 mm diameter) and make your tenons 19 mm wide to suit. It will make the morticing easier.

MITRE CUTTING

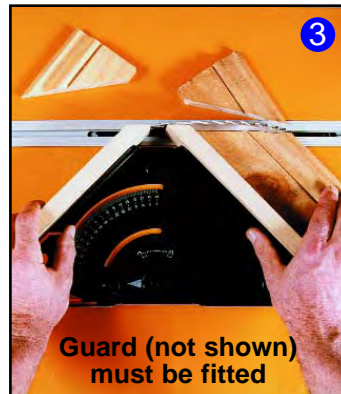
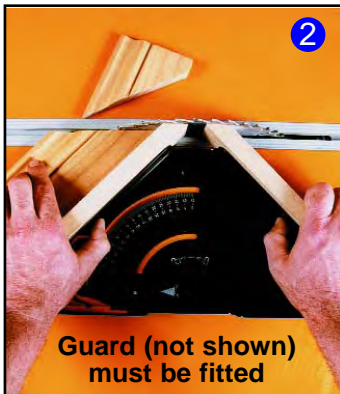

Set the protractor at 45° . Make sure both knobs are tightened and that the protractor slides freely. Hold a straight piece of wood against whichever face of the protractor best supports the workpiece near the blade.

Hold the wood firmly against the protractor during the cut, otherwise it will tend to "creep".

The protractor can be used in either of the two outer slots, and either way around to suit your job.

Fit subfences (400-500mm long) to the protractor ② & ③ for good workpiece support and a precise means of lining up your cuts. Face them with glued-on sandpaper strips.

Cut about 150mm off the end of a piece of scrap. Place the offcut against the main piece and see if they form a perfect right-angle. If necessary, adjust the protractor angle slightly.

If the wood you are cutting is flat on both faces, cut the reverse mitre at the other end by turning the piece end-for-end, and lying it on its back for the second cut. Or preferably, cut the reverse angle on the adjacent face (as shown in ④ & ⑤). See explanation in blue text below.

MITRE CUTTING MOULDING



If the workpiece cannot be turned over, (e.g. moulded picture framing or beading) make the first cut with the workpiece held against one 45° face of the protractor ④, and cut the reverse angle mitre with it held against the other 45° face. ⑤

Mouldings should always be cut with their flat base resting against the table, and the taller edge against the face of the protractor. Because the moulded face is always upwards, there will be less visible splintering.

The two shorter faces of the protractor form a perfect right angle. So a piece cut against one face, when placed against a piece cut against the other face will always form a perfect right angle, whatever the angle. For example, if the protractor was accidentally set at 44° , the other face would give you 46° , totalling 90° .

Similarly, 30° off one face will give you 60° off the other. By selecting the correct angle, you can use this method when mitre joining pieces of differing widths.

MITRE CUTTING TO A LENGTH STOP



To ensure perfect length accuracy when mitre cutting, fit an extension sub-fence (or two) to the protractor, and clamp a mitred block to one of them. ①

Cut the first mitre against the face which does not have the stop, and then place the mitred end against the stop block, for the reverse angle mitre. Both cuts can thus be made with the moulded face upwards, for less visible splintering.

Grip the workpieces firmly because there is a tendency for them to “creep”. It’s a good idea to glue sandpaper to the face of the sub-fence(s).

If you are making square or rectangular frames, cut all of your pieces to a length stop to ensure that each frame comes out perfectly square, with tight corners. Your protractor must be set at exactly 45° .

CUTTING SHARP POINTS OR WEDGES

Sharp stakes, pegs or wedges can be safely cut on the Workcentre by using the long face of the protractor - set at say 10° - and making two or four cuts, turning the wood over after the each cut.

You must use an extended sub-fence ②, because the protractor face does not give sufficient support - especially after the first cut. Also your fingers would have to pass too close to the blade for safety without the sub-fence.



Preferably butt the far end of the workpiece up against a stop block attached to the sub-fence. It ensures the points will be central without measuring, marking or sighting up, and makes it easier to hold the workpiece. If the workpiece is too long to fit a sub-fence and stop block, you can sight up cuts by using a line squared around each workpiece - say 100 mm in from the end - and referencing it to a pencil mark on the sub-fence. ②

If the workpiece is heavy, or over about 750mm long, cut it in the crosscut mode.

19 x 45mm (2" x 1") on edge is an ideal size for a sub-fence. Chamfer or rebate the end to allow full height adjustment for the overhead guard.

Adjust the overhead guard so the workpiece just passes underneath and keep the blade as low as possible. Lower the blade to below table level and rehearse this cut without power to confirm your hand positions.

Be careful of the small wedge-shaped off-cuts. They can vibrate into the blade and become re-cut or flung out, or they can become wedged in the table slot beside the blade. Keep a stick handy to move them away from the blade after each cut. If one becomes wedged in the slot, stop cutting, switch off, and wait until the blade stops completely before removing the jammed off-cut.

OPERATING - Crosscut Mode

Always wear eye protection. Hearing protection and a dust mask are also highly recommended.



RECOMMENDED OPERATING POSITION

Stand near the switchbox, on the right hand side of the Workcentre as shown. ① Hold the workpiece with your right hand and push the saw with the left. Even though this stance may seem unusual at first, it gives better control over the workpiece, and will soon feel quite natural.

Do not operate the Workcentre from the left hand side as shown in ②. Your hand access is limited, and you cannot hold the wood close to where it is being cut.



Make a test traverse of the saw, with the power switched off, before inserting the workpiece. Do this whenever you've adjusted the saw blade angle or raised the table - for example after using the Workcentre in the overhead router mode.

Always keep hands outside the bearing channels and well out of the path of the blade. Hold the workpiece firmly or use clamps if necessary. Make sure the workpiece and the offcut are well supported, during and after each cut.

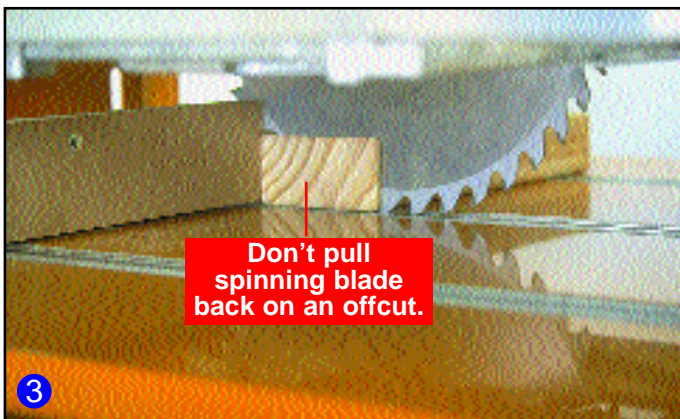

Do not pull the saw back towards you until the blade has stopped. You could hit the offcut with the back of the blade, and cause possible damage or injury. ③

If the back of the blade slightly re-cuts the workpiece as it's slowing to a halt, remove the workpiece sideways as soon as the blade has cut fully through.

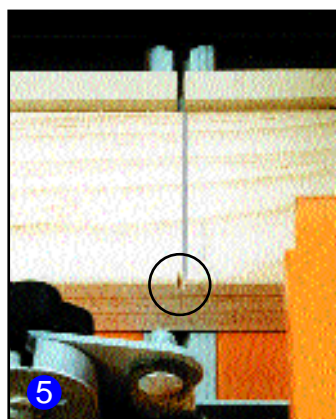
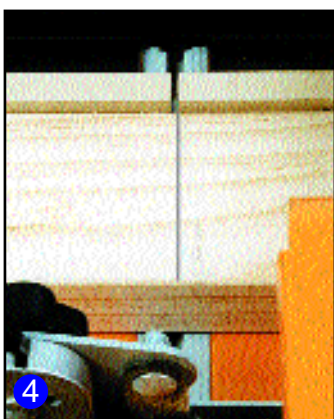

Use the cut that you made in the MDF sub-fence to sight up your future cuts. Place the pencil mark on your workpiece to the left or right side of the cut mark, depending on which side of the line you want to cut. ④ Periodically adjust the sub-fences inwards and re-cut the ends for accurate lining up.

A test "nick" (circled) on the edge of the wood is a useful way of seeing whether your wood is in the right spot. You can then move it slightly one way or the other before making the proper cut. ⑤



MULTIPLE CROSSCUTTING

If cutting two or more pieces to the same length, rough-cut them to length, a little longer than you'll need. Then line up the dressed ends, and cut the other ends in one pass. You could tape the pieces together if you wish. ❶

You only need to measure and mark one of the pieces - the one closest to the MDF sub-fence - all the pieces will be cut to exactly the same length.

REBATING (DADOING)

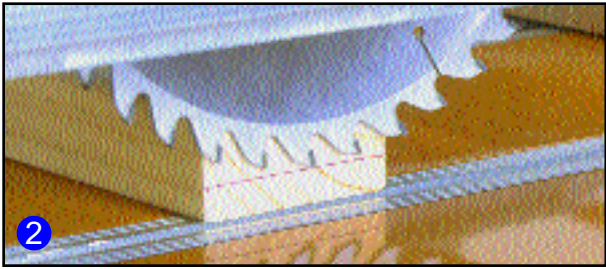

If you only want to partially cut through a workpiece, simply raise the blade and make a series of cuts.

To set the blade to a desired height, raise or lower it until the lowest tooth is just level with a line drawn on a piece of scrap sitting on the table. This allows you to use both hands to adjust the saw, rather than having to hold a ruler as well. ❷

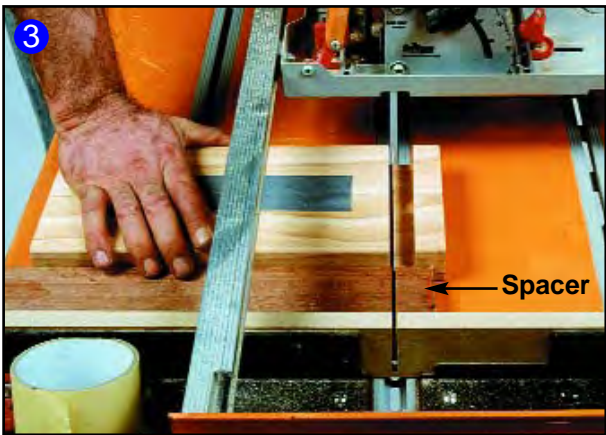

Move the piece(s) sideways by one blade-width after each cut. If cutting several pieces, tape them together.

Pull the saw back fully clear of the wood before moving the wood sideways.

Try putting a parallel-sided packing spacer, ❸, say 100-200mm wide, between the workpiece and the crosscut fence. It will bring the work closer to you and you'll avoid back strain. If you have a saw with a long baseplate, a packing spacer may be needed in any case to complete the rebate.

DOUBLE CUTTING

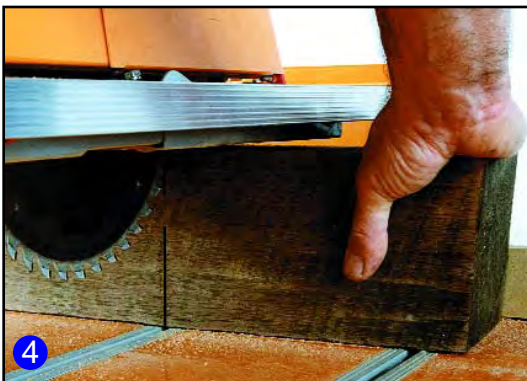

For cutting wood thicker than your saw depth of cut, you can lower the table. Mark your current table settings with a marker pen, and lower the table support rails at the front and the rear panel. The calibration scales reflect the thickness of wood that can be inserted, i.e. for 90 mm timber, set the red markers at around 92 mm.

The table should be lowered from the normal position by the same amount at all four corners, even if you've built in a compensating slope. (See Saw Slump section on Page 13)

Cut the workpiece a little more than half-way through. Then turn it over and make the second cut. ❹

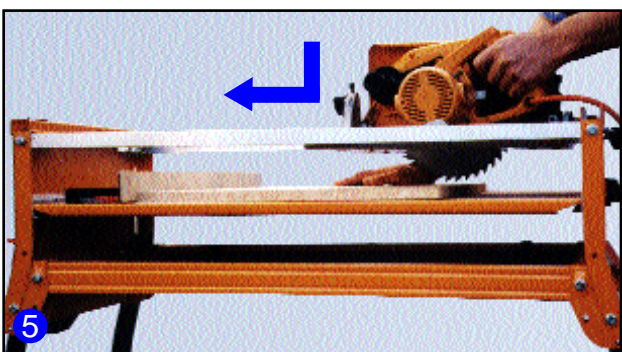

PLUNGE CUTTING

You can increase the width of cut in the crosscut mode by raising the blade to admit a wider board. Switch on the power, plunge the spinning blade down on the work, then continue the cut as normal. ❺

Make sure the saw's safety guard is held back by the rear of the slide chassis or by a rubber band, string etc. Do not attempt these cuts unless the saw raises and lowers smoothly, and reasonably accurately.

CROSSCUTTING WIDER WORKPIECES

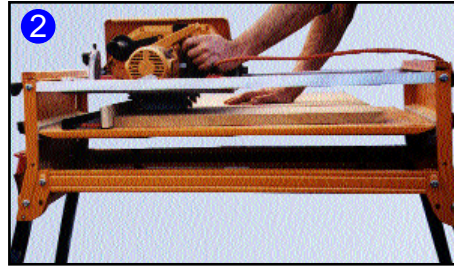
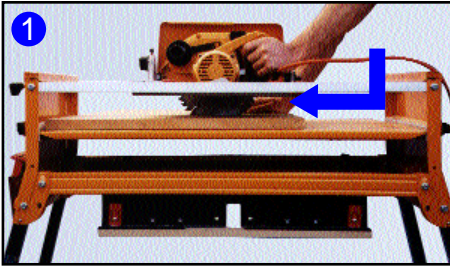

For workpieces up to 680mm wide, remove the crosscut fence and rest the workpiece against the rear table support rail. Plunge in and cut as far as you can. ❶ Switch off and wait until the saw stops. Pull the saw and work towards the front panel. Fit the crosscut fence, line up the blade centrally in the kerf, and complete the cut. ❷

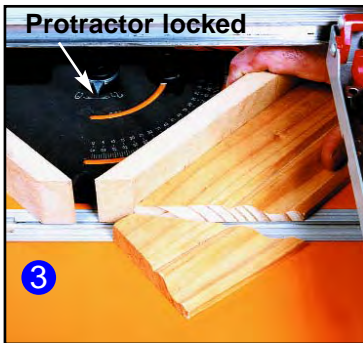

MITRE CUTTING

Remove the crosscut fence (if necessary), and fit the protractor to the right hand table slot. Lock it in in the slot by loosening the central knob and turning the pointer to the \square position. ❸ Tighten the knob.

Set the desired angle using the knob near the scale and lock it tightly.

Hold the workpiece **firmly** against the sandpaper face and make the cut. Let the blade stop spinning before pulling the saw back. Always ensure the protractor is providing support next to the blade slot.

Sight up mitre cuts by opening the side guard and touching the stationary blade against the cutting mark. Alternatively, attach sub-fences to your protractor as in ❸ & ❹. The 45° trimmed ends will be your sighting reference.

BEVEL MITRES (COMPOUND CUTS)



Remove the crosscut fence and lock the protractor in its slot, set at the required angle. Tilt the blade to the desired angle. **DO NOT RAISE THE TABLE**, as the blade is no longer above the slot. Use thin packing under the workpiece to raise it up to the blade. ❺

Hold the workpiece firmly against the angled protractor face, and keep fingers well clear of the blade. Avoid twisting the handgrip of the saw as you push.

Bevel cuts put a lot of load on the workpiece and the saw. Make sure the workpiece doesn't creep during the cut.

If you have arbor float in your saw, or a poor blade, make a second shaving cut.

If the packing is clamped to the table, the blade score line can be used for lining up future cuts.

BEVEL CUTTING



Study "Bevel Mitres" above, but use the crosscut fence rather than the protractor to rest the wood against.

Before making a cut, check that the blade will not hit the crosscut fence or any part of the table or aluminium track. Hold the wood firmly as it will tend to move sideways.

Make a dedicated platform for bevel sawing. ❻ It has shallow strips glued under both edges, 644mm apart, for a snug fit on the table. The score line in the platform, and the 45° cut in the MDF fence will provide reference marks for lining up cuts. Sandpaper strips glued onto the subfence will help prevent the wood moving.

Cut bevels two or more at a time for length accuracy. Preferably tape them together, as shown.

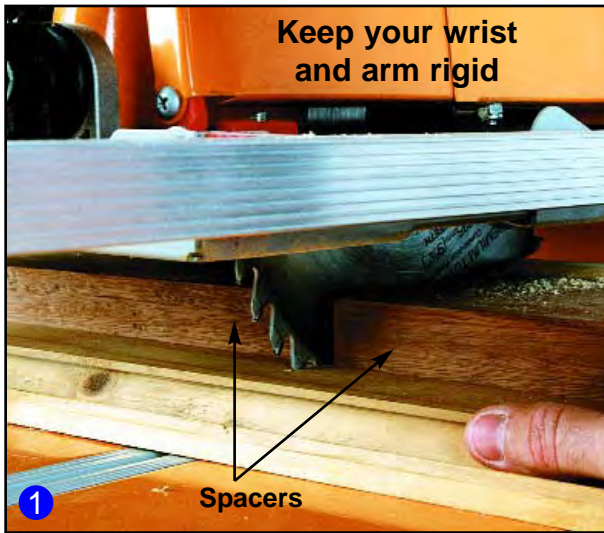

CLIMB CUTTING

Climb cutting (or pulling the saw backwards into the work) is useful with thin or flexible material, such as fine moulding, which tends to lift off the table when cut normally. You will need a sharp TCT blade and packing spacers (150-200mm wide) between your work and the MDF sub-fences on the crosscut fence. ① Temporarily remove the riving knife (if fitted) from your saw.

Tightly lock the blade height adjuster. Keep your arm and wrist rigid. The saw will want to “climb” on your work. You must control it firmly.

A climb cut gives less splintering on the top face, so is also useful for cutting mouldings such as architrave.

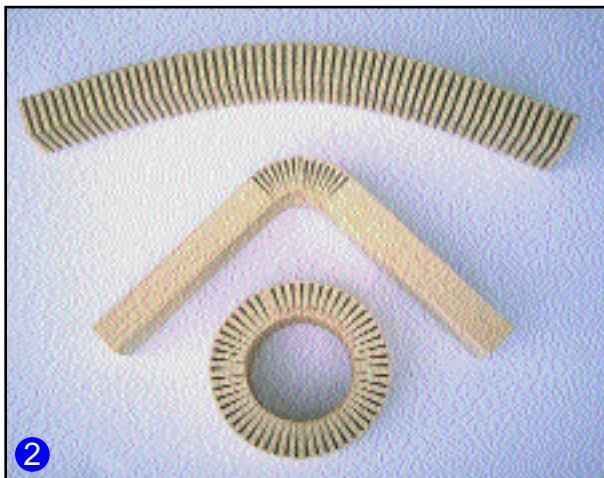

KERFING (BENDING WOOD)

A series of parallel cross cuts - evenly spaced - almost all the way through a piece of wood enables you to bend it. The radius of bend depends largely on the spacing between cuts.

Experiment with how much to leave uncut: it depends on the species, the grain, and the moisture content. As a rule of thumb, leave between 2mm and 5mm uncut.

For evenly spaced cuts, make a pencil mark the width of the blade on the sub-fence or on a packing spacer ③. Make a cut, move the wood sideways until the cut is lined up with the pencil mark, and make the next cut, and so on.

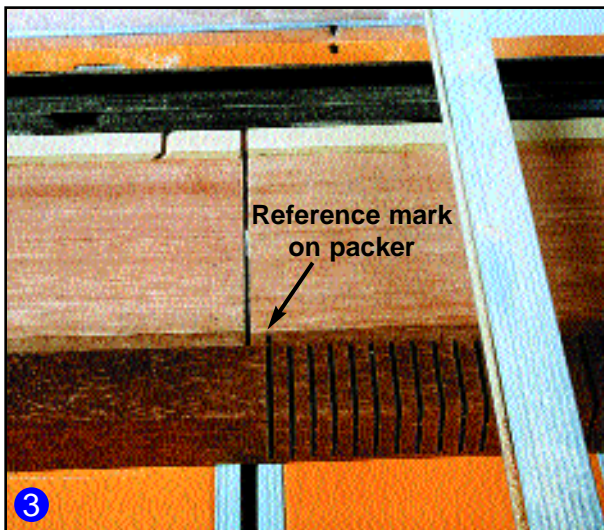

Avoid twisting the hand-grip of the saw. Preferably, lock on the trigger with the trigger strap, control the power via the switchbox, and push the slide chassis rather than the saw.

You may find that 14 cuts, say, gives you less than a right-angle, and 15 cuts gives you more. If you want 90°, try making the first and fourteenth cuts a little wider than the rest, by making a shaving cut beside the normal cut. It will effectively give you 14½ cuts, unobtrusively.

Avoid using knotty, or short-grained material. Ideally use straight grained material with a high moisture content. After cutting, use great care in handling kerfed pieces. Do not bend them backwards. Always close up the cuts. Perhaps make the bend in stages by pinning, clamping or tying it in a gradually tightening radius. Consider using steam to assist bending.

Strengthen a kerf if necessary by filling the cuts with two-pack epoxy, epoxy putty or tinted body filler. For decorative purposes, it generally does not need to be filled, just well glued on the inside face using a high quality PVA glue.

HANDY STORAGE OF GUIDES

All the attachments for the Workcentre have on-board storage locations.

Fit the overhead guard to the T-slot in the rip fence, fold the arms of the fence inwards, and clip the fence into the fence hangers. The crosscut fence hangs neatly from either of the base channels using its rear lip. ① & ②



The Protractor (G) can be stored on the two red hooks on the rear panel, or can temporarily hang from either of the pushstick hangers on the front panel during a working session. ②

When finished work for the day. Release the saw safety guard, remove the trigger strap and unplug the saw.

DUST COLLECTION

Protect your health and keep your workshop clean by using the optional Triton Dust Bag (DCA250). Connect any vacuum cleaner to the overhead guard hose supplied and collect almost 100% of the dust created in the tablesaw mode.

The Dust Collector (DCA300) prevents saw dust filling up or clogging your vacuum cleaner. It provides a huge 20 litre capacity and can also be used with the Series 2000 Router Table and the Biscuit Joiner.



CUSTOMER SATISFACTION

We aim for extremely high levels of customer satisfaction. If there's anything we can do to improve our products or services, please let us know. If you're completely satisfied, please tell your friends.

Make sure you get onto our mailing list by returning the enclosed Warranty Registration Coupon. We'll send you details of future product updates and accessories.

Made in Australia by: Triton Manufacturing & Design Co. Pty. Ltd. ACN 006 021 683
14-18 Mills St, Cheltenham, Vic. 3192 Ph: (03) 9584 6977 Fax: (03) 9584 5510
E-mail: tools@triton.net.au Web Site: <http://triton.net.au>

Australia: Vic - (03) 9584 6977 **NSW** - (02) 9822 4111 **Qld** - (07) 3252 7666
SA - (08) 8340 2833 **WA** - (089) 350 5588 **Tas** - (0363) 44 7060

International Offices: **Canada** - Free Call: 1 888 874 8661 **Japan** - Free Call: 0120 171 079
New Zealand - Ph: 9415 2545 **South Africa** - Free Call: 0800 600 432
United Kingdom - Free Call: 0800 856 7600

Due to our company policy of continuous product improvement, specifications may change without prior notice.